

UNIVERSITY OF CINCINNATI

DATE: 05/20/2003

I, Sujan Balachandran ,

hereby submit this as part of the requirements for the degree of:

Master of Sciences

in:

Industrial Engineering

It is entitled:

**Data Repository for Autonomous guided vehicle
using ASP.NET**

Approved by:

Dr. Ernest L. Hall

Dr. Richard L. Shell

Dr. Ronald L.
Houston

Data Repository for Autonomous guided vehicle using ASP.NET

A thesis submitted to the
Division of Graduate studies and Research
Of the University of Cincinnati

In partial fulfillment of the
requirements for the degree of
Master of Science
in the Department of Mechanical, Industrial and Nuclear Engineering
Of the College of Engineering
2003

by

Sujan Balachandran

B.E (Mechanical Engineering)

Sri Venkateswara College of Engineering, Madras University, India, 2000.

Thesis Advisor and Committee Chair: **Dr. Ernest L. Hall**

Acknowledgement:

I would like to thank my advisor, Dr. Ernest Hall, without whose guidance and support this thesis would not have been possible. His suggestions and feedback had greatly helped me in my thesis and I am really grateful for his help and support.

I would like to thank Dr. Richard L. Shell and Dr. Ronald L. Huston for agreeing to chair the committee. I would also like to thank them for their suggestions and positive feedbacks.

I would like to thank the Robotics Team members for all the help and support they had given me during my graduate period of study at the University Of Cincinnati. I would like to thank all my friends and well-wishers who had helped me from time to time.

Last but not the least, I would like to thank my family for their encouragement and support in all my endeavors. I owe all my success to them.

Abstract

The Internet is a public, cooperative, and self-sustaining facility accessible to hundreds of millions of people worldwide. Since information and knowledge transfer is critical for the success and continuous enhancement of any product it is imperative to keep abreast with technological innovations. Data repositories, over the World Wide Web, is one such innovations used for information sharing and updating. With the introduction of the .NET technology, by the Microsoft Inc., the whole internet technology is looking forward towards an era of integrating and unifying different language platforms into one single framework.

This thesis elaborates on the use of .NET technology in developing a data repository. It is an experimentation to learn and adopt this technology into information sharing methods of the UC Robotics team. This tool, for information sharing, should be very helpful for the team when it wants to retrieve and update information about the team proceedings from any remote location such as working on-site for the IGVC competitions.

The Data Repository is built using ASP.Net as the framework and VB.Net as the coding language. The back end database used is Access, for reasons of its easy operability and scalability.

Table of Contents:

Chapter 1	7
Introduction	7
Objective	7
Organization of Thesis	8
Chapter 2	9
Bearcat III	9
Components of Bearcat III	9
Line Following	10
Vision System	10
Motion Control System.....	11
Mechanical System.....	11
Obstacle Avoidance.....	12
Design Solution using Laser Scanner for Fine Detection	12
Design Solution using Sonar System for Coarse Detection	14
Pothole Detection	14
Waypoint Navigation.....	14
Waypoint Navigation Using Global Positioning System.....	15
Navigational Challenge Solution Approach.....	15
Description of Navigational Challenge Algorithm.....	15
Algorithm Implementation	16
Point to Point Navigation using Wheel Encoders	17
Power System.....	17
Safety System.....	18
Manual Emergency Stop	18
Remote Controlled Emergency Stop	18
Health Monitoring System	19
Overall System Integration	19
Chapter 3	20
Internet Technology and .NET	20
Hypertext Transfer Protocol	20
Web pages can be classified into two	21
Static Web pages.....	21
Dynamic web pages.....	21
Two ways of providing Dynamic Web page content.....	22
Client side technologies	22
Server Side Technologies.....	22
More on .NET and ASP.NET.....	23
.NET Framework.....	23
Some of the topics of discussion for the .NET Framework.....	23
What is Machine code?.....	24
Pre-Compiled code	24
Interpreted code.....	24
What is Common, Intermediate Language	24
.NET Pros	25
.NET Cons	25
How ASP.NET works.....	25
Chapter 4	27
Database	27
What do you mean by data? What is Metadata?.....	27
What is a database? Why do we need it?	27

What is a data Repository?	27
Database Management System (DBMS).....	27
Relational database.....	28
Steps involved in Database Design	28
Conceptual Schema	28
Logical Schema.....	28
Physical Schema.....	28
Open Database Connectivity	29
Structured Query Language.....	30
Chapter 5.....	31
More about ASP.NET.....	31
Asp vs ASP.NET.....	31
Language Support.....	31
ASP .NET Controls	31
Event Aware Controls	32
High Scalability.....	32
Compiled Code	32
Easy Configuration.....	32
Easy Deployment	32
Compatibility	33
What You Need.....	33
A Windows Computer	33
Windows 2000 or XP.....	33
Service Packs and Updates.....	33
Install .NET	34
ASP .NET - Web Pages.....	34
Example Code.....	34
ASP .NET - Server Controls	35
ASP .NET - HTML Server Controls	35
ASP .NET - Web Server Controls	36
ASP .NET - Validation Server Controls	37
Here is the list of ASP.NET web server controls	37
Chapter 6.....	39
Building the Data Repository.....	39
Schematic representation of the Data Repository	40
Different Modules in the Data Repository	41
Login Screen.....	42
Selection Page.....	42
Member Details	43
Sponsor Details	45
System Components	46
Failure Modes	47
Technical Details	48
Chapter 7.....	50
Conclusions and Recommendations	50
References.....	51
Appendix	53

List of Figures:

Figure 1. Bearcat III Block Diagram	9
Figure 2 (Left) Two Windows are used to Capture Two Points on the Boundary Line,(Right) Robot in Relation to the Line	10
Figure 3 Motion Control System Block Diagram.....	11
Figure 4 The Mechanical System.....	12
Figure 5 Field of View of the Laser Scanner.....	13
Figure 6 Sonar Obstacle Detection System	13
Figure 7 View of Simulated Potholes	15
Figure 8 Concept of Point to Point Motion.....	17
Figure 9 World Wide Web Architecture.....	21
Figure 10 Various Phases of Database Design	29
Figure 11 ODBC Architecture	30
Figure 12 Steps Involved in creating Data Repository	39
Figure 13 Components of Data Repository	40
Figure 14 Login Screen Shot	42
Figure 15 Selection Page Screen.....	43
Figure 16 Administrator Screen for Member Information	44
Figure 17 User Screen for Member Information	44
Figure 18 Administrator Screen for Sponsor Information.....	45
Figure 19 User Screen shot for Sponsor Information.....	46
Figure 20 Administrator Screen for Component Information	47
Figure 21 User Screen for Component Information	47
Figure 22 Administrator Screen for Failure Modes	48
Figure 23 User Screen for Failure Modes	48
Figure 24 Administrator Screen for Technical Details	49
Figure 25 User Screen for Technical Details	49

Chapter 1

Introduction

Internet technology has revolutionized the whole world in its methods of information sharing. In this new era of combined education and collective learning, the learning still seems to be incomplete if there is no one single platform or framework through which information is shared. The whole idea of the Microsoft Incorporation in bring the .NET technology is to bring about this change. The thesis also delves on recommending such a change for the UC Robotics Team, by implementing a Data Repository to store, retrieve and share its data.

The UC Center for Robotics is a research group of engineers, who have built intelligent autonomous vehicles. The team participates in the Annual Intelligent ground Robotics competition every year and is continuously working on adding technical enhancements to the autonomous guide vehicle, Bearcat. So it becomes important for every member to understand the complexities of every system involved for the effective functioning of the group. Building a data repository will provide answers to questions technical or otherwise and lead to better communication and better understanding of the robot.

Objective

Lack of information at the right time is the main source of bottlenecking, and stagnation in any project. This can be reduced to a great extent by choosing and adopting the right methodology for information storage, retrieval and sharing. In the existing era of information sharing through internet, it would be wise to capitalize on it for its speed.

The UC Robotics team also faced such problems of lack of information about something because of the nonexistence of a centralized data repository. This leads to a noticeable slowdown in the work while working on site, especially in the annual intelligent ground robotics competition.

The main objective of this project is to minimize such a backlog in workflow due to lack of information. The project uses the internet technology specifically the .NET technology for data management and elaborates its uses, implementation methods, advantages and disadvantages. The solution will empower users, current as well as future, to have a better understanding of the various components and it will serve as an excellent tool for design, analysis and effective decision-making.

Organization of Thesis

To facilitate ease of reading the thesis is segmented into chapters. The segmentation is carried out in such a way that it provides easy understanding. Chapter 2 describes the various components of the autonomous guide vehicle Bearcat III. Chapter 3 gives a brief outline of the components that are crucial for the building of web to database application. Chapter 4 describes the underlying concepts in building a database. Chapter 5 introduces the basic components, methods, procedures in ASP.NET using VB.NET to implement any project. Chapter 6 sketches the implementation of Data Repository in ASP.NET using VB.NET. Chapter 7 outlines the recommendations for future enhancements.

Chapter 2

Bearcat III

The Bearcat III is an intelligent, Autonomous Guided Vehicle (AGV) designed to compete in the 10th Intelligent Ground Vehicle Competition that is to be held, July 6 – 8, 2002 at the Coronado Springs Hotel near Walt Disney World, Orlando, FL. This vehicle was designed to perform all the tasks and obey all of the rules required for the contest.

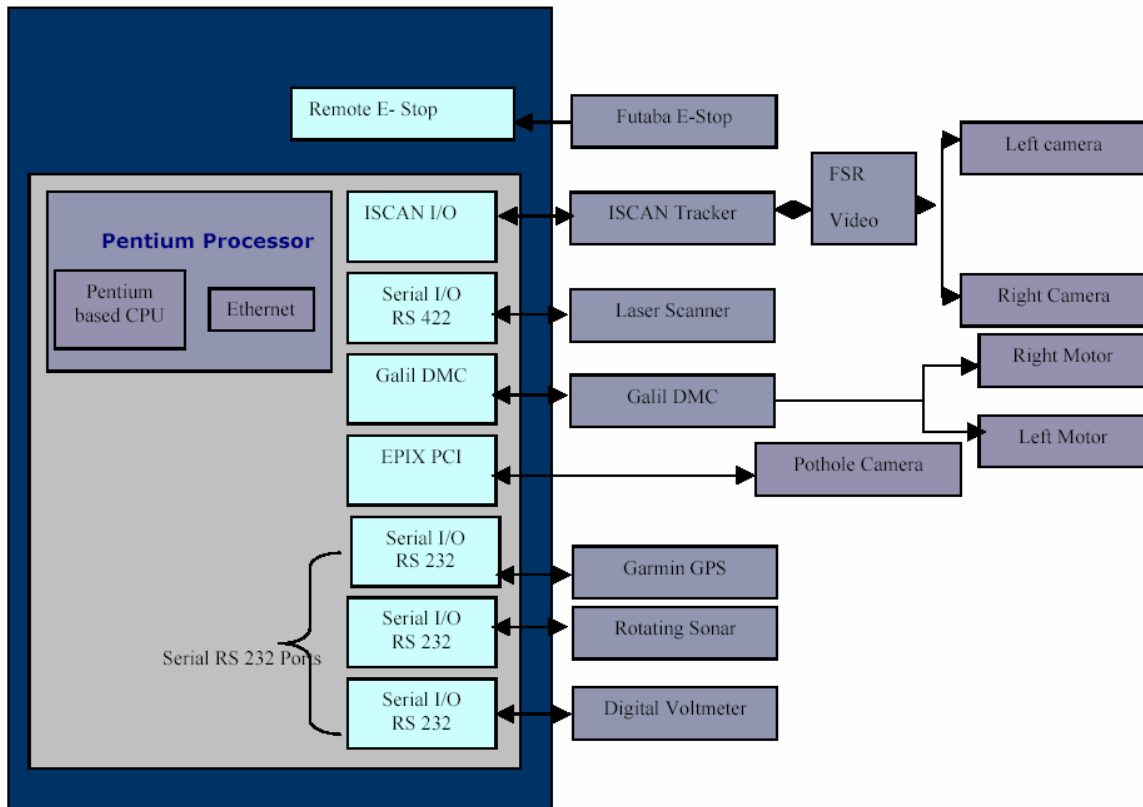

Figure 1. Bearcat III Block Diagram

Components of Bearcat III

The purpose of this chapter is to explore the various functional components that make up Bearcat III. The automated guided vehicle is an integration of numerous functional subsystems controlled by means of a high-level central computer that enables the vehicle to function as an intelligent machine. Each sub-system is designed to meet or assist with a specific contest requirement. Next few pages will have a description of the contest requirements and the Bearcat III design to meet the challenge.

Line Following

The Bearcat III was designed to negotiate around an outdoor obstacle course under a prescribed time while staying within the 5 mph speed limit and avoiding the obstacles on the track.

Vision System

The Bearcat's vision system for the autonomous challenge comprises three cameras, two for line following and one for pothole detection. The vision system for line following uses 2 CCD cameras and an image tracking device (ISCAN) for the front end processing of the image captured by the cameras. ISCAN tracker is used to process the image of the line; the tracker finds the centroid of the brightest or darkest region in a captured image. The three dimensional world co-ordinates were reduced to two dimensional image coordinates as a result of the transformations taking place from the ground plane to the image plane. A novel four-point calibration system was designed to transform the image co-ordinates back to world co-ordinates for navigation purposes. Camera calibration is a process to determine the relationship between a given 3-D coordinate system (world coordinates) and the 2-D image plane a camera perceives (image coordinates). The objective of the vision system is to make the robot follow a line using a camera. At any given instance the Bearcat tracks only one line, either right or left. If track is lost from one side, then the central controller through a video switch changes to the other camera.

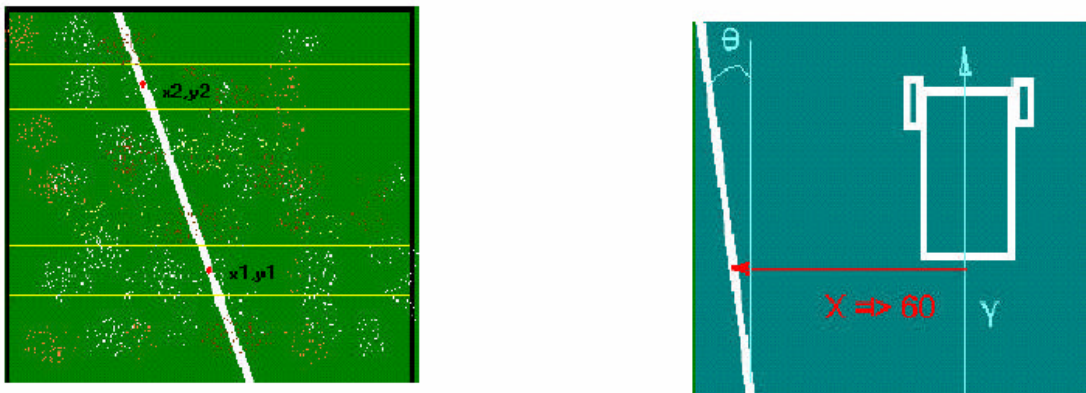

Figure 2 (Left) Two Windows are used to Capture Two Points on the Boundary Line, (Right) Robot in Relation to the Line

In order to obtain accurate information about the position of the line with respect to the centroid of the robot, the distance and the angle of the line with respect to the centroid of the robot has to be known. When the robot is run in its auto-mode, two ISCAN windows are formed at the top and bottom of the image screen as shown in Figure 5. The centroids of the line segments are returned

by the ISCAN tracker these are shown as points (x_1, y_1) and (x_2, y_2) in Figure 5. These data-points help us to determine the angle and distance of the line with the robot as shown in Figure 6. The calculated distance and angle work as inputs for the motion control system.

Motion Control System

The motion control system shown in the Figure 7 enables the vehicle to move along a path parallel to the track and to negotiate curves. Steering is achieved by applying differential speeds at the left and the right wheels. Manipulating the sum and difference of the speed of the right wheels, the velocity and orientation of the vehicle can be controlled at any instant. Two motors power the gear train. The motor torque is increased by a factor of 40 using worm and worm gear train. The power to each motor is delivered through an amplifier that amplifies the signal from the Galil DMC Motion Controller. The data from the vision and obstacle avoidance systems work as an input to the central controller to give commands to the motion control system to drive the vehicle.

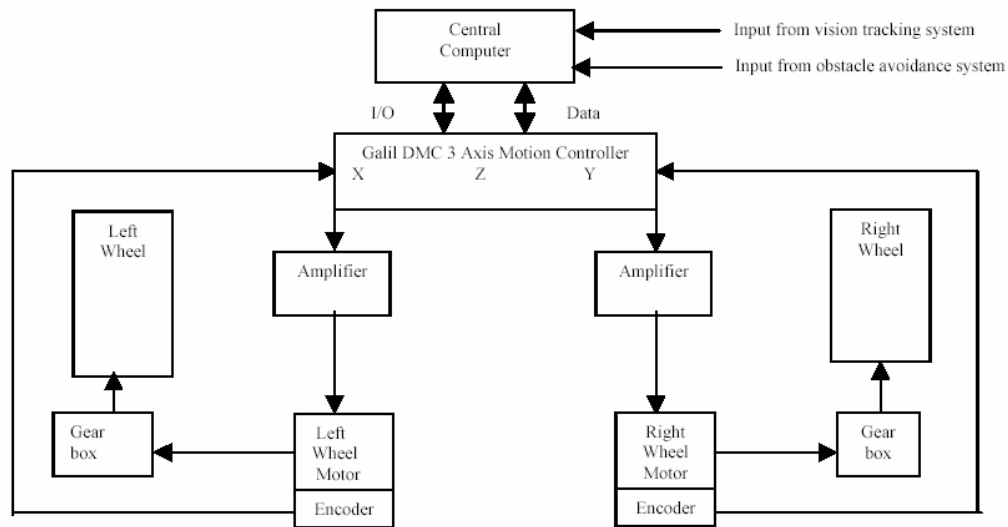

Figure 3 Motion Control System Block Diagram

Mechanical System

The Bearcat III is designed to be an outdoor vehicle able to carry a payload of 100 pounds. Optimal design was arrived using good design practices during basic design and CAD software such as AutoCAD R14 and IDEAS Master series 7.0 were used in the final analysis phase for stress and load analysis. The basic structure goes with the aluminum extrusions, joining plates and T-nuts. The frame is designed with an extruded aluminum structure to hold the components of the vehicle.



Figure 4 The Mechanical System

Obstacle Avoidance

The obstacle avoidance system detects an obstacle on the navigational course and then calls the appropriate software routine to negotiate it. Two alternative solutions one using a laser scanner and one with the Sonar sensors are used on the bearcat for obstacle detection and avoidance. Both the approaches are explained below.

Design Solution using Laser Scanner for Fine Detection

The Bearcat uses the SICK laser scanner (LMS 200) for sensing obstacles in the path. The power supply to the unit is through a 24Volt, 1.8 Amp adapter. The unit communicates with the central computer using a RS422 serial interface card. The maximum range of the scanner is 32 meters. For the contest, a range of 8 meters with a resolution of 11 has been selected. The scanner data is used to get information about the distance of the obstacle from the robot. This can be used to calculate the size of the obstacle. The scanner is mounted at a height of 8 inches above the ground to facilitate the detection of short as well as tall objects. The central controller performs the logic

for obstacle avoidance and the integration of this system with the line following and the motion control systems.

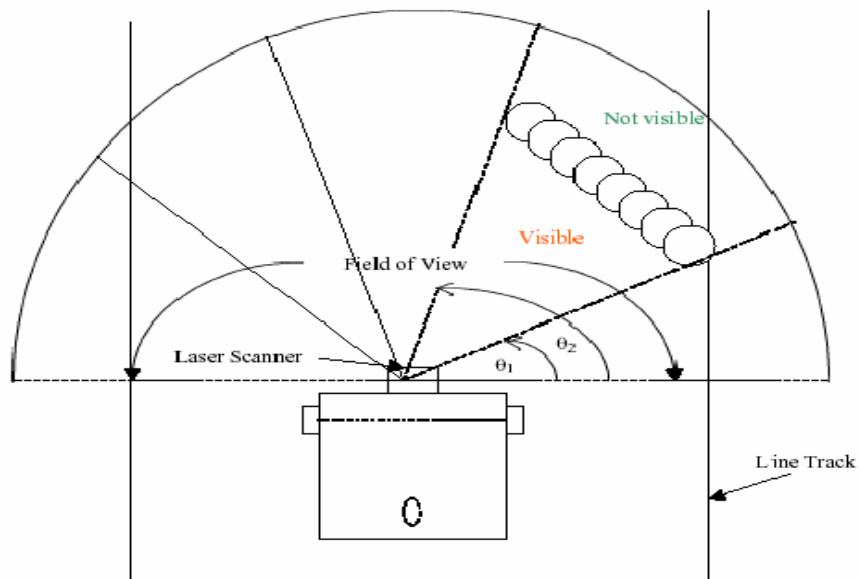

Figure 5 Field of View of the Laser Scanner

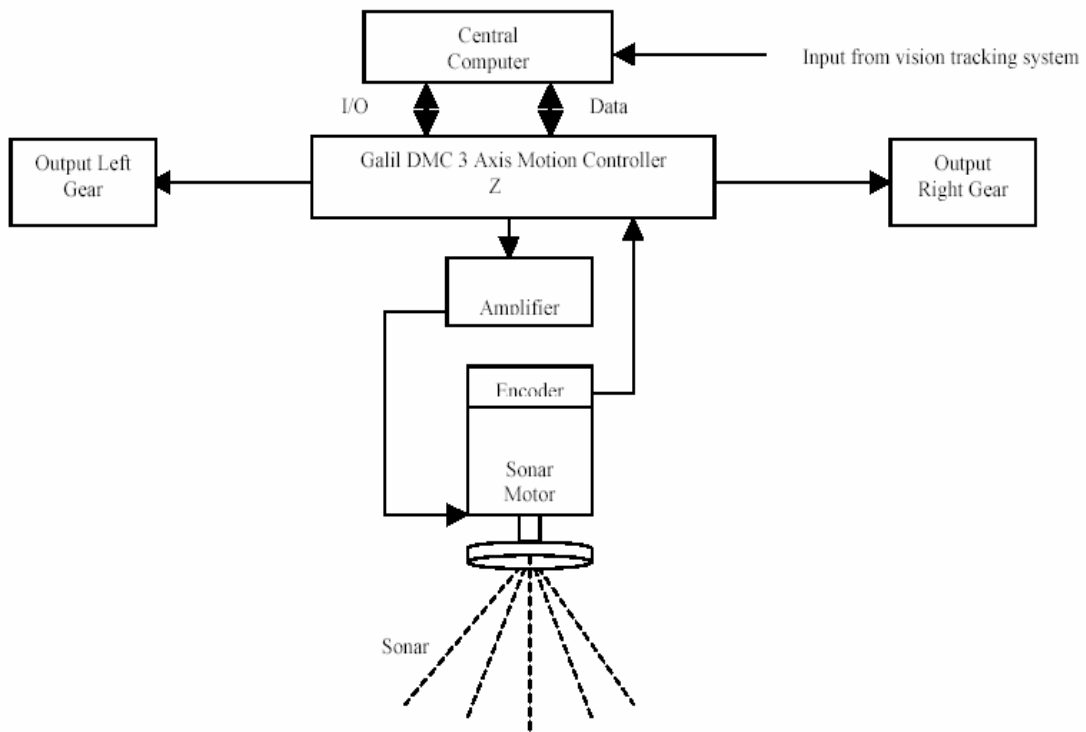

Figure 6 Sonar Obstacle Detection System

Design Solution using Sonar System for Coarse Detection

The two main components of the ultrasonic ranging system are the transducers and the drive motor as shown in Figure 10. A 12 Volts DC, 0.5 Amps unit powers the sonar. A “time of flight” approach is used to compute the distance from any obstacle. The sonar transmits sound waves towards the target, detects an echo, and measures the elapsed time between the start of the transmit pulse and the reception of the echo pulse. The transducer sweep is achieved by using a motor and Galil motion control system. Adjusting the Polaroid system parameters and synchronizing them with the motion of the motor permits measuring distance values at known angles with respect to the centroid of the vehicle. The distance value is returned through an RS232 serial Port to the central controller. The central controller uses this input to drive the motion control system. The range of this system is 40 feet.

Pothole Detection

The robot has the ability to detect and avoid simulated potholes represented by two feet diameter white circles randomly positioned along the course. A non-contact vision approach has been taken since simulated potholes are significantly different visually from the background surface. A monochrome Panasonic CCD camera is used to capture the course ahead of the robot. The data from the camera is fed to the Epix imaging board through the video switch. The control software for the imaging board processes the formatted data. This software makes extensive use of the XCOBJ/PXIPL Image Processing libraries provided by EPIX to detect the presence of a simulated pothole and determine the location of the centroid of the pothole. The line following, obstacle avoidance and pothole detection systems integrate for pothole detection and avoidance. The obstacle avoidance system takes precedence over the pothole avoidance system. Figure 11 shows view of simulated potholes that can be detected.

Waypoint Navigation

Bearcat-III is designed to autonomously travel from a starting point to a number of target destinations and return to home base, avoiding obstacles in the course, knowing the coordinates of those targets. The waypoint navigation is achieved by using a differential GPS as explained below.

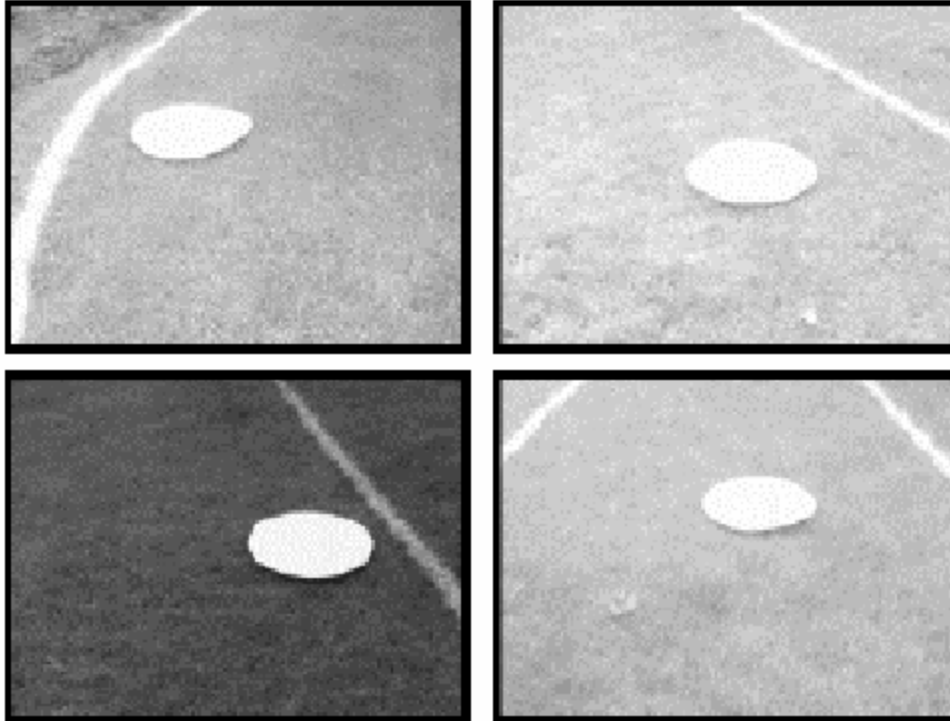

Figure 7 View of Simulated Potholes

Waypoint Navigation Using Global Positioning System

Navigational Challenge Solution Approach

The methodology behind the Bearcat navigational challenge problem was to select a commercially available GPS unit and utilize the built in features of the unit to provide a solution to the GPS navigational problem. This approach relies on the GPS unit's navigational processing features and reduces the computational load that the robot CPU must perform to navigate the course. The basic criteria used in the selection of the GPS unit are WAAS (Wide Area Augmentation System) capability, RS-232 serial port input/output ability, external antenna, external power capability, and embedded navigation features. Based on these selection criteria the Garmin GPS 76 was chosen as the unit to provide GPS navigational ability to the robot. The major navigational features of the GPS unit used in the solution of the GPS navigational problem are the ability to input/output NMEA (National Marine Electronics Association) messages, set target waypoints, and calculate bearing/range information to the target waypoint.

Description of Navigational Challenge Algorithm

The solution selected to solve the navigational challenge problem is to model the problem as a closed feedback control loop. The input command is the target waypoint destination. A feedback signal is provided by the GPS unit position information. The GPS unit uses the current position information and calculates the bearing, track, and range from the target waypoint. The bearing, track, and range to the target waypoint are used to calculate the error signal. Correction signals are generated to reduce the error to a certain tolerance based on the turn angle error signal calculated from the GPS unit output data. The corrective commands are sent to the robot motion control system, which translates these commands into motor control voltages that steer and propel the robot on the course.

The robot may not always be able to reach its intended target waypoint directly because of obstacles on the path. To handle this situation, a laser scanner is used to detect obstacles within an 8 meter zone in front of the robot. The control of the robot is transferred to the obstacle avoidance routine once an obstacle is detected in the path of the robot. The target waypoint command is replaced with the target point that will guide the robot around the path obstacle. Once the robot successfully avoids the obstacles, the original target waypoint is restored and the navigational feedback control loop is resumed.

Algorithm Implementation

The physical implementation of GPS navigation feedback control loop consists of the Garmin 76 GPS unit, the robot motion control system, laser scanner, and the robot computer. Waypoint coordinates are read from the waypoints file during the initialization stage of the program and stored in an array in memory. A NMEA message is sent to the Garmin 76 GPS unit via the RS 232 port, which sets the active target waypoint in the GPS unit's memory, this is the command signal. Once set, the waypoint coordinate is used by the GPS unit to calculate bearing, track, and range to the target waypoint.

The Garmin 76 GPS unit transmits ASCII data output via the RS232 port containing the bearing, track, and range to the destination waypoint. The turn angle (angle error) is related to the track angle and bearing angle by the equation: $\text{Turn Angle} = \text{Track Angle} - \text{Bearing Angle}$. This equation gives the turn angle in the 0 to 360 degree reference frame but this angle is transformed to 0 to 180 degrees (left turn angle) or 0 to -180 degrees (right turn angle) for the robot turning subroutine. The robot turns to the commanded correction turn angle if the turn angle is greater than 6 degrees or less than -6 degrees and then moves forward until the GPS position data are updated. When the robot arrives within 5 feet of the destination waypoint the next target waypoint

is selected and this process is repeated until all targets have been reached. This process defines the discrete feedback control loop algorithm used for the robot GPS navigation course.

The robot computer handles the communications interface with the Garmin 76, laser scanner, and motion control system devices. It is also responsible for running the digital feedback control algorithm code and sending the correction commands to the robot motion control system.

Point to Point Navigation using Wheel Encoders

An encoder translates motion into electrical pulses, which are fed back into the Galil motion controller. The feedback is used to calculate the distance traversed. Steering is achieved by differential motion of the two wheels. The problem is modeled as a closed feedback control loop. The input command is the target waypoint destination relative to the robot position. The wheel encoder provides the feedback signal. The motion from the origin A to target B is achieved by two motions. The program calculates Angle “a” and distance “d”. The robot first steers “a” units and it then traverses “d” units to reach the target. Figure 12 shows the concept of navigation using wheel encoders.

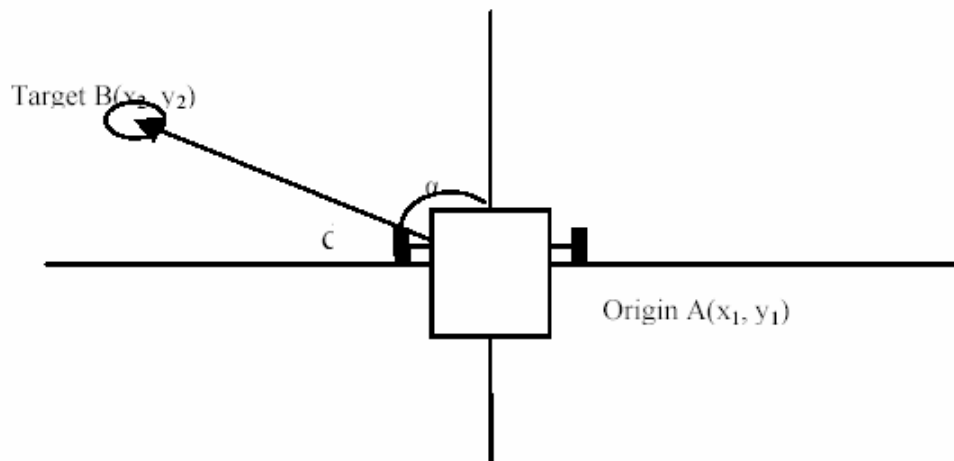

Figure 8 Concept of Point to Point Motion

Power System

The Bearcat’s electrical system consists of a DC battery power system that supports an AC power system through an inverter. Three 12-Volt DC, 130 Amp hours, deep-cycle marine batteries connected in series provide a total of 36 Volts DC, 4680 Amp hours for the main electrical power. A 36-Volt, DC input, 600-Watt inverter provides 60 Hz pure sine wave output at 115

Volts AC. The inverter supplies AC electrical power for all AC systems including the main computer, cameras, and auxiliary regulated DC power supplies. An uninterruptible power source (UPS) interfaces the robot main computer with the AC power system. The UPS provides 3 minutes of emergency power to the main computer during AC power system interruptions. The UPS allows the main computer to be properly shutdown or connected to an external power source if the main robot AC power system is offline. The DC system provides 36 volts unregulated DC electrical power to the motors at a maximum of 10 Amps. The total power required by the Bearcat is approximately 735 Watts for the DC systems and 411.3 Watts for the AC systems. Thus, 1146-Watts total power is required to operate the Bearcat III. A loss of 10 percent was estimated for the required power to yield 1261 Watts actually required. A 10 percent loss can also be assumed for power supplied by the batteries to yield 4212 watt hours available. Based on these estimates the Bearcat III power system has an estimated endurance of 3.34 hours at full load. A spare set of batteries is available and will be needed during the contest runs.

Safety System

Manual Emergency Stop

The manual emergency stop unit consists of a red manual push button located on the easily accessible rear surface of the vehicle. When pressed, the power to the motors is cut off and the self-locking mechanism of the gearbox brings the vehicle to an instant halt. The self-locking mechanism ensures that the vehicle does not move when it is not powered, and serves as a safety measure against any undesirable motion such as rolling when parked on a slope.

Remote Controlled Emergency Stop

The mobile robot must be de-activated by a remote unit from a distance of no less than 50 feet in compliance with the rules for this contest. The remote controlled emergency stop consists of a Futaba transmitter, a receiver, an amplifier and a relay. The advantage of using this is that the transmitter need not be in line with the sight of the receiver. The Futaba transmitter uses a 6V DC and transmits FM signals at 72.470 MHz over a range of 65 feet. This amplified current activates the contacts of the relay that in turn activates the emergency stop solenoid and cuts power to the motors.

Health Monitoring System

The Bearcat III is equipped with a self-health monitoring system. A RS 232 serial port is used to take input from a digital multi meter, which can be accessed from C++ code to check the total DC voltage of the batteries. The health monitoring is implemented as a C++ class module that has methods that can monitor battery voltage and display warning messages to the computer screen. Two voltage threshold trip points can be set that will trigger a low voltage and a critical low voltage warning message. The low voltage warning indicates that the battery voltage is below the first threshold trip point and that preparations should be made to change or charge the batteries. The critical low voltage warning indicates that corrective actions must be taken immediately because robot power system shutdown is eminent. The voltmeter class can also be used in code to sound an audible alarm or activate the robot strobe light at the specified threshold point. The power system voltage display is also visible to the operator and provides a constant indication of the robot electrical voltage.

Overall System Integration

For the autonomous challenge-line following the inputs comes from the vision system: as image coordinates of the track to be followed, Obstacle avoidance system: as laser scanner/sonar data and pothole detection data. These inputs are processed by the central controller to give commands to the motion control system, which drives the mechanical drive train. For the Navigational challenge data from the navigation system: as the GPS data and from the obstacle avoidance system: as the laser scanner/sonar data are used as inputs by the central controller to give commands to the motion control system which drives the mechanical drive train.

Chapter 3

Internet Technology and .NET

Worldwide network of computers connected together through a standard network protocol known as transmission Control protocol or TCP/IP.

Advantages of Internet

<i>Internet Characteristics</i>	<i>Benefit</i>
Hardware and Software Independence	<ul style="list-style-type: none">• Savings in equipment/software acquisition.• Runs on most existing environment.• No need for multiple platform development.
Location Independence	<ul style="list-style-type: none">• Global access through Internet infrastructure.• Reduced costs for dedicated connections.
Common and simple user interface	<ul style="list-style-type: none">• Reduced training costs and times.• Reduced costs on end user support.• No need for multiple platform development.
Rapid development at manageable costs	<ul style="list-style-type: none">• Multiple development tools available• Plug and Play development tools• Development is more interactive• Reduced development times• Tools are relatively inexpensive• Free client access tools (Web Browser)• Low entry costs-Free web servers available.• Reduces costs of maintaining private networks.• Distributed processing using multiple servers.

Hypertext Transfer Protocol

The standard protocol used by the Web Browser and the Web server to communicate i.e. to send requests and replies between servers and browsers.

A text document containing labels of special commands written in Hypertext Markup language.

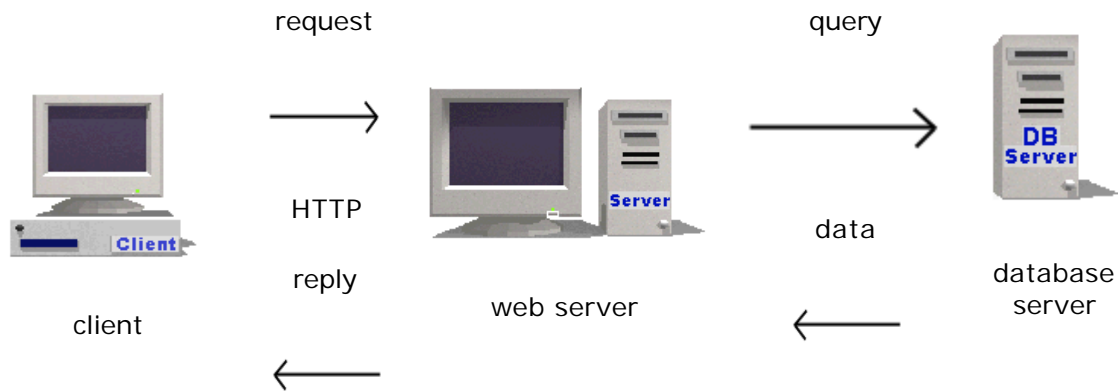

Figure 9 World Wide Web Architecture

Web pages can be classified into two

Static Web Pages

Dynamic Web Pages

Static Web pages

Static web page content is determined at the time of writing the document. As implied above, every request for a static page gives the same response. Static Web pages are simple and easy to create. They can be viewed quickly and can be stored as local copies, on the client's computer, for quicker access in the future. Problem with static web pages is the lack of adaptability. If a static page needs to be changed, someone has to manually change the code on each revision. This can take up lots of time if the validity of the information in the file expires frequently.

Dynamic web pages

Dynamic web pages changes appearance depending upon what information is stored in the database. Rather than writing an HTML page, instructions on how to make the page are written. The server then creates the actual HTML and presents the data in a readable form. This technique allows the development of incredibly rich content on the Internet. Dynamic web pages do not

require any extra processing on the client's machine as against static pages, so they are generally faster.

Two ways of providing Dynamic Web page content

The two ways of providing dynamic web page content are client side and server side technologies.

Client side technologies

In the client side models, modules attached to the browser do all the work of creating dynamic pages. The HTML code is typically sent to browser along with separate file containing a set of instructions, which is referenced from within the HTML page.

Client-side technologies have fallen down in the recent times, as they take a long time to download, especially if we have to download a second file with separate instructions. Another problem with this is that each browser interprets this set of instructions in different ways. So the trend moved towards server side scripting.

To name some client side technologies are HTML, DHTML, XHTML, JavaScript, and VBScript.

Server Side Technologies

With the server model, the HTML source is sent to the web server with an intermingled set of instructions. Again this set of instructions will be used to generate HTML for the page at the time the user requests the page. Once again the page is dynamically generated upon request.

Essentially, all the processing is done in the server, before the page is sent back to the browser. The advantage of this being, you are taking all the processing load away from the browser enabling a faster response and that there is not much of anomalies at the client side with the use of different browsers.

Some server side technologies are CGI, JSP, Java, ASP and the latest addition to it is the ASP.NET.

More on .NET and ASP.NET

At the heart of the .NET technology is the .Net framework, which provides the core technology that underpins it all. The framework itself consists of several components, of which ASP. NET is just one.

.NET Framework

The .NET Framework is the infrastructure for the new Microsoft .NET Platform. The .NET Framework is a common environment for building, deploying, and running Web applications and Web Services.

The .NET Framework contains a common language runtime and common class libraries - like ADO .NET, ASP .NET and Windows Forms - to provide advanced standard services that can be integrated into a variety of computer systems.

The .NET Framework provides a feature-rich application environment, simplified development and easy integration between a numbers of different development languages.

The .NET Framework is language neutral. Currently it supports C++, C#, Visual Basic, and JScript (The Microsoft version of JavaScript).

Microsoft's Visual Studio.NET is a common development environment for the new .NET Framework.

Some of the topics of discussion for the .NET Framework

MS Intermediate Language- All the code written is compiled into more abstract, trimmed down form before it is executed. Whichever .Net language is used to write the code, the trimmed code that's created from it is defined using MSIL: the common language of the .NET

The Common Language Runtime (CLR) - This is a complex system responsible for executing the MSIL code on the computer. It takes care of tall the nitty-gritty tasks involved in talking to the Windows Internet Information System (IIS).

The .Net framework Class Libraries- these are code libraries containing a mass of tremendously useful functionality, which we can very easily bolt into our own application to make complex tasks much more straightforward.

The .Net languages – These are simply programming languages that conform to certain specific structural requirements (as defined by the common language specification), and can therefore be compiled to MSIL.

ASP.NET – This is how the .Net framework exposes itself to the web, using IIS to manage simple pages of code, so that they can be compiled into full .Net programs. These are then used to generate HTML that can be sent out to browsers.

From your code to Machine Code

What is Machine code?

It is needless to say that a machine understandable code is one that is comprised only of 1's and 0's. This referred to as the binary coding. It is almost impossible for anybody to remember the sequence of codes in this language. This led to the development of programming languages. These of two types performing the following respectively:

Pre-Compiled code

This is the code that we compile before we need to use it. So that it is ready and waiting to be executed on the hardware.

Interpreted code

This code gets compiled as and when we decide to execute it.

What is Common, Intermediate Language

When a program is written in .Net framework – perhaps using VB.Net or C#, we must always compile this human-readable code before using it. The way that, Net's compilers are designed however, means that this only goes half way to the binary code that presents such problems of portability. In fact, they compile our code into a special format, called the MS intermediate

Language to be easily human-readable as our original code. Consequently, it does not have to be nearly so verbose, clearly structured, or neatly arranged.

When this is executed, we effectively pass it to the CLR, which is really the cornerstone of the .Net framework. Just as the .Net framework lies at the heart of the Microsoft .Net vision, the Common Language Runtime (CLR) lies right at the heart of the framework. Its main purpose is to take care of executing any code that is been fed into it, and to deal with all the nightmarishly complicated jobs that Windows and IIS require doing in order to work properly. The CLR uses another compiler – the JIT (Just-in-Time) compiler- to compile to true machine code, and make any last minute, machine-specific optimization to the program, so that it can run as quickly as possible on the specific machine it inhabits.

Thus MSIL, .NET's Common language gives us both, structural optimization of pre-compiled code along with portability of interpreted code.

.NET Advantages

- It offers multiple language support.
- It has a rich set of libraries, a la JVM.
- Its open-standard friendly (e.g., HTTP and XML) -- it may even become a standard itself.
- Its code is compiled natively, regardless of language or deployment (Web or desktop).

.NET Disadvantages

- It is yet another platform to consider, which generally means rewriting and learning new tricks.
- Microsoft tends to have good ideas, but mediocre implementation.
- Currently, it's only available on Windows.
- Microsoft claims C#, IL, and CLR/CLS will be submitted to ECMA, but there's still no clear view on what will be standardized from the platform.

How ASP.NET works

For most purposes, ASP.Net pages can be thought of just like normal HTML pages that have certain marked up for special consideration. When .Net is installed, the local IIS web server is

automatically configured to look out for files with the extension ‘.aspx’ and to use the ASP.NET module to handle them.

Technically speaking, this module parses the contents of the ‘.aspx’ file; it breaks them down into separate commands in order to establish the overall structure of our code. Having done this, it arranges the command within a pre-defined class definition, not necessarily together, and not necessarily in the order in which we wrote them. That class is then used to define a special ASP.NET page object, and one of the tasks this object then performs is to generate a stream of HTML that can be sent to IIS and from here, back to the client.

Chapter 4

Database

What do you mean by data? What is Metadata?

The term Data refers to known facts that could be recorded and stored. Data that has been stored is processed in such a way as to increase the knowledge of the person who uses the data. Data when processed in this form is called information.

Metadata refers to that data which describes the properties or characteristics of other data. “Data about Data”

What is a database? Why do we need it?

Database is defined as an organized collection of logically related data. A database may be of any size and complexity.

Data constitute the building blocks of information. Good, relevant and timely information is the key to good decision-making. Since a good database is a good information generator, a systematic approach to database design is very important for the building of any database application. In any practical application, a database that can provide interactive and organized data is necessary for effective communication and knowledge transfer.

What is a data Repository?

A data repository is a centralized knowledge base of all data definitions, data relationships, screen and report formats, and other system components.

Database Management System (DBMS)

A software (occasionally hardware, firmware) system used to define, create, maintain, and provide controlled access to the database and also to the repository.

Relational database

The relational database model was devised by E. F. Codd and is based on the branch of mathematics called set theory. The relation stores data in the form of tables. The tables are otherwise known as relations. Each table is a matrix, consisting of series of rows and columns. The rows from a relational table are analogous to a record, and the columns to a field. The main advantage of this model is structural independence i.e. ability to make changes in the database structure without affecting the DBMS's ability to access the data. The software used to control this type of databases is called relational database Management Systems (RDBMS).

Steps involved in Database Design

The various phases that are involved in the database design methodology of a fault diagnosis system are as follows.

Conceptual Schema

Finding out the requirements involved in developing is the first step. They will feed number of entities, attribute names, and types of data stored in each attribute. Once the entities and attributes are listed, then the relationship between these entities has to be mapped. A graphical representation of this conceptual understanding of the data model is called an Entity Relationship Diagram (ERD).

Logical Schema

This is the intermediate step which translates our conceptual understanding of the data model to the physical level. This is a phase where a lot of cleaning up takes place. To name some are,

Identification of the Primary keys from a set of Candidate Keys

Normalization

Physical Schema

This is the final product, with the tables and data fields ready for us to enter and store data.

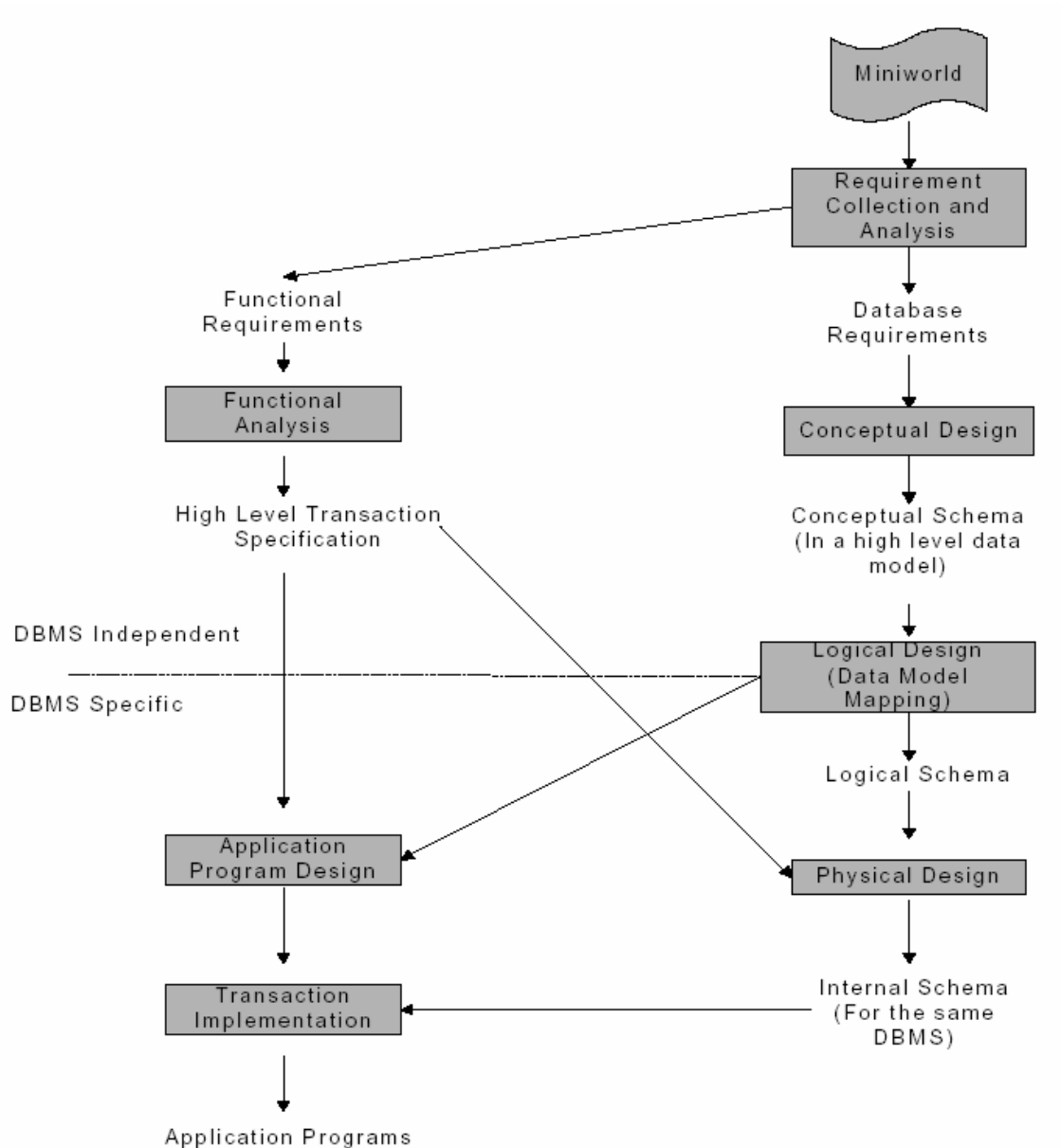

Figure 10 Various Phases of Database Design

Open Database Connectivity

One of the typical requests in an application environment is a database search. To search efficiently any web to database middleware needs to have the database ready for access when requests come in. If each time the program receives a request it has to open the database file, search the records and then close the file, it would be inefficient and would be unable to handle multiple requests pouring in simultaneously.

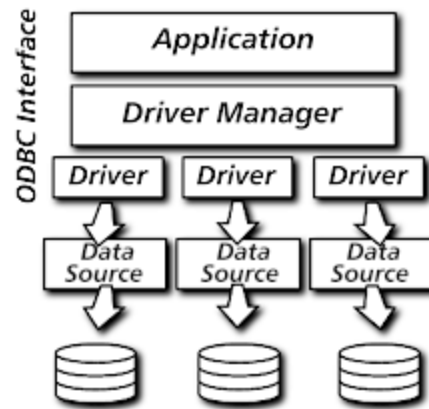

Figure 11 ODBC Architecture

Open database connectivity source establishes a data pipeline in and out of the database, making it readily accessible. When ODBC is installed in the system a set of drivers that are compatible with a variety of common database applications are automatically installed. A driver is software that enables the system software to communicate with hardware or other software. The operating system communicates with the various hardware and software by way of drivers. ODBC allows any windows application to access data sources that are in relational database systems, using standard SQL (Structured Query Language).

Structured Query Language

Structured query language is a universal set of commands that programs such as ASP.NET use to communicate with a database. SQL allows users to access data in relational database management systems, such as Oracle, Sybase, Informix, Microsoft SQL Server, and Access, by allowing users to describe the data, which the user wishes to see. SQL also allows users to define data in a database, and manipulate that data. SQL statements are also used to perform tasks such as updating data in a database, or retrieve data from a database. SQL statements are in short the industry standard for relational database management and for creating, defining and managing databases.

Chapter 5

More about ASP.NET

ASP .NET is the next generation ASP, but it's not an upgraded version of ASP. ASP .NET is an entirely new paradigm for server-side ASP scripting.

ASP .NET is a part of the new .NET (dot net) Framework. Microsoft spent three years rewriting ASP .NET from the ground up, and ASP .NET is not fully backward compatible with ASP 3.0

Asp vs. ASP.NET

- Better Language Support
- Programmable Controls
- Event Driven Programming
- XML Based Components
- Higher Scalability
- Increased Performance - Compiled Code
- Easier Configuration and Deployment
- Not Fully ASP Compatible

Language Support

ASP .NET uses the new ADO .NET.

ASP .NET supports full Visual Basic, not VBScript.

ASP .NET supports C# (C sharp) and C++.

ASP .NET supports JScript as before

ASP .NET Controls

ASP .NET contains a large set of HTML controls. Almost all HTML elements on a page can be defined as ASP .NET control objects that can be controlled by scripts.

ASP .NET also contains a new set of object oriented input controls, like programmable list boxes, validation controls.

A new data grid control supports sorting, data paging, and everything you expect from a dataset control.

Event Aware Controls

All ASP .NET objects on a Web page can expose events that can be processed by ASP .NET code.

Load, Click and Change events handled by code makes coding much simpler and much better organized.

High Scalability

Much has been done with ASP .NET to provide greater scalability.

Server to server communication has been greatly enhanced, making it possible to scale an application over several servers. One example of this is the ability to run XML parsers, XSL transformations and even resource hungry session objects on other servers.

Compiled Code

The first request for an ASP .NET page on the server will compile the ASP .NET code and keep a cached copy in memory. The result of this is greatly increased performance.

Easy Configuration

Configuration of ASP .NET is done with plain text files.

Configuration files can be uploaded or changed while the application is running. No need to restart the server. No more met abase or registry puzzle.

Easy Deployment

No more server restart to deploy or replace compiled code. ASP .NET simply redirects all new requests to the new code.

Compatibility

ASP .NET is not fully compatible with earlier versions of ASP, so most of the old ASP code will need some changes to run under ASP .NET.

To overcome this problem, ASP .NET uses a new file extension ".aspx". This will make ASP .NET applications able to run side by side with standard ASP applications on the same server.

What You Need

A Windows Computer

ASP .NET is a Microsoft technology. To run ASP .NET you need a computer capable of running Windows.

Windows 2000 or XP

If you are serious about developing ASP .NET applications you should install Windows 2000 Professional or Windows XP Professional.

In both cases, make sure you install the Internet Information Services (IIS) from the Add/Remove Windows components dialog.

Service Packs and Updates

Before ASP .NET can be installed on your computer, it is necessary to have all relevant service packs and security updates installed.

The easiest way to do this is to activate your Windows Internet Update. When you access the Windows Update page, you will be instructed to install the latest service packs and all critical security updates. For Windows 2000, make sure you install Service Pack 2. I will also recommend that you install Internet Explorer 6.

Read the note about connection speed and download time at the bottom of this page.

Install .NET

From your Windows Update you can now select to install the Microsoft .NET Framework. After download, the .NET framework will install itself on your computer. There are not any options to select for the installation.

ASP .NET - Web Pages

Fundamentally an ASP .NET page is just the same as an HTML page.

An HTML page has the extension .html. If a browser requests an HTML page from the server, the server sends the page to the browser without any modifications.

An ASP .NET page has the extension .aspx. If a browser requests an ASP .NET page, the server processes any executable code in the page, before the result is sent to the browser.

The ASP .NET page above does not contain any executable code, so nothing is executed. In the next examples we will add some executable code to the page to demonstrate the difference between static HTML pages and dynamic ASP pages.

Example Code

HTMLHelloWorld.aspx

```
<Html>
<body bgcolor="yellow">
<center>
<h2>Hello World! </h2>
</center>
</body>
</html>
```

The code above is essentially a HTML code; it could have been saved as a HTML document, but saving it as an .aspx document still valid. But there is no dynamism introduced in the page.

ASPHelloWorld.aspx

```
<html>
<body bgcolor="yellow">
<center>
```

```
<h2>Hello World!</h2>
<p><%Response.Write(now())%></p>
</center>
</body>
</html>
```

Active Server Pages (ASP) has been around for several years. With ASP, executable code can be placed inside HTML pages.

Previous versions of ASP (before ASP .NET) are often called Classic ASP.

ASP .NET is not fully compatible with Classic ASP, but most Classic ASP pages will work fine as ASP .NET pages, with only minor changes.

ASP .NET - Server Controls

ASP .NET has solved the "spaghetti-code" problem described above with server controls. Server controls are tags that are understood by the server.

There are three kinds of server controls

- # HTML Server Controls - Traditional HTML tags
- # Web Server Controls - New ASP .NET tags
- # Validation Server Controls - For input validation

ASP .NET - HTML Server Controls

HTML server controls are HTML tags understood by the server.

HTML elements in ASP .NET files are, by default, treated as text. To make these elements programmable, add a `runat="server"` attribute to the HTML element. This attribute indicates that the element should be treated as a server control.

Note: All HTML server controls must be within a `<form>` tag with the `runat="server"` attribute. The `runat="server"` attribute indicates that the form should be processed on the server. It also indicates that the enclosed controls can be accessed by server scripts.

In the following example we declare an HtmlAnchor server control in an .aspx file. Then we set the href attribute of the HtmlAnchor control in an event handler (an event handler is a subroutine that executes code for a given event). The Page_Load event is one of many events that ASP .NET understands:

```
<script runat="server">
Sub Page_Load
link1.HRef="http://www.w3schools.com"
End Sub
</script>
<html>
<body>
<form runat="server">
<a id="link1" runat="server">Visit W3Schools!</a>
</form>
</body>
</html>
```

The executable code itself has been moved outside the HTML.

ASP .NET - Web Server Controls

Web server controls are special ASP .NET tags understood by the server.

Like HTML server controls, Web server controls are also created on the server and they require a runat="server" attribute to work. However, Web server controls do not necessarily map to any existing HTML elements and they may represent more complex elements.

The syntax for creating a Web server control is

In the following example we declare a Button server control in an .aspx file. Then we create an event handler for the Click event which changes the text on the button:

```
<script runat="server">
Sub submit(Source As Object, e As EventArgs)
button1.Text="You clicked me!"
End Sub
</script>
<html>
<body>
<form runat="server">
<asp:Button id="button1" Text="Click me!"
runat="server" OnClick="submit"/>
</form>
</body>
</html>
```

ASP .NET - Validation Server Controls

Validation server controls is used to validate user-input. If the user-input does not pass validation, it will display an error message to the user.

Each validation control performs a specific type of validation (like validating against a specific value or a range of values).

By default, page validation is performed when a Button, Image Button, or Link Button control is clicked. You can prevent validation when a button control is clicked by setting the Causes Validation property to false.

The syntax for creating a Validation server control is

In the following example, we declare one Textbox control, one Button control, and one Range Validator control in an .aspx file. If validation fails, the text "The value must be from 1 to 100!" will be displayed in the Range Validator control:

```
<html>
<body>
<form runat="server">
Enter a number from 1 to 100:
<asp:TextBox id="tbox1" runat="server" />
<br /><br />
<asp:Button Text="Submit" runat="server" />
<br />
<asp:RangeValidator
ControlToValidate="tbox1"
MinimumValue="1"
MaximumValue="100"
Type="Integer"
EnableClientScript="false"
Text="The value must be from 1 to 100!"
runat="server" />
</form>
</body>
</html>
```

Here is the list of ASP.NET web server controls

Web Server Control	Description
AdRotator	Displays a sequence of images

Button	Displays a push button
Calendar	Displays a calendar
Checkbox	Displays a check box
Checkbox List	Creates a multi-selection check box group
DataGrid	Displays fields of a data source in a grid
DataList	Displays items from a data source by using templates
DropDown List	Creates a drop-down list
Hyperlink	Creates a hyperlink
Image	Displays an image
Image Button	Displays a clickable image
Label	Displays static content which is programmable (lets you apply styles to its content)
Link Button	Creates a hyperlink button
List Box	Creates a single - or multi-selection drop-down list
Literal	Displays static content which is programmable (does not let you apply styles to its content)
Panel	Provides a container for other controls
Placeholder	Reserves space for controls added by code
Radio Button	Creates a radio button
RadioButtonList	Creates a group of radio buttons
Repeater	Displays a repeated list of items bound to the control
Table	Creates a table
TableCell	Creates a table cell
TableRow	Creates a table row
Textbox	Creates a text box
Xml	Displays an XML file or the results of an XSL transform

Chapter 6

Building the Data Repository

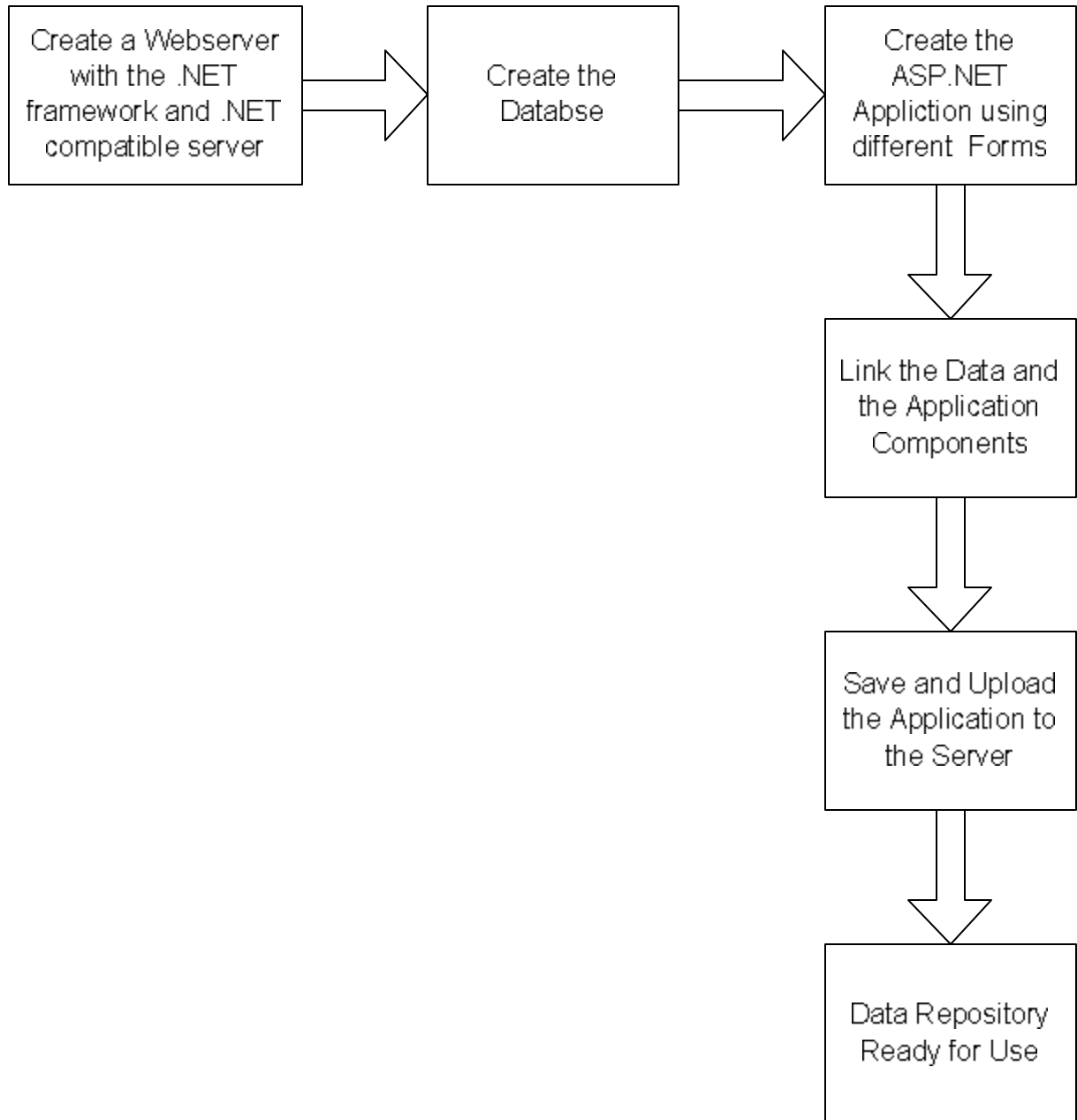

the design and development of the Database. The project uses Access as its Database since it is very scalable and simple to build and make it compatible with the Application System.

The major portion of the project involved the development of the Application suit using the VB. NET platform to code and build project in ASP. NET. It involved design and development of different forms. Finally the application system has to be loaded in the server and tested. The project is viewed using an internet browser like Internet Explorer or Netscape Navigator.

Schematic representation of the Data Repository

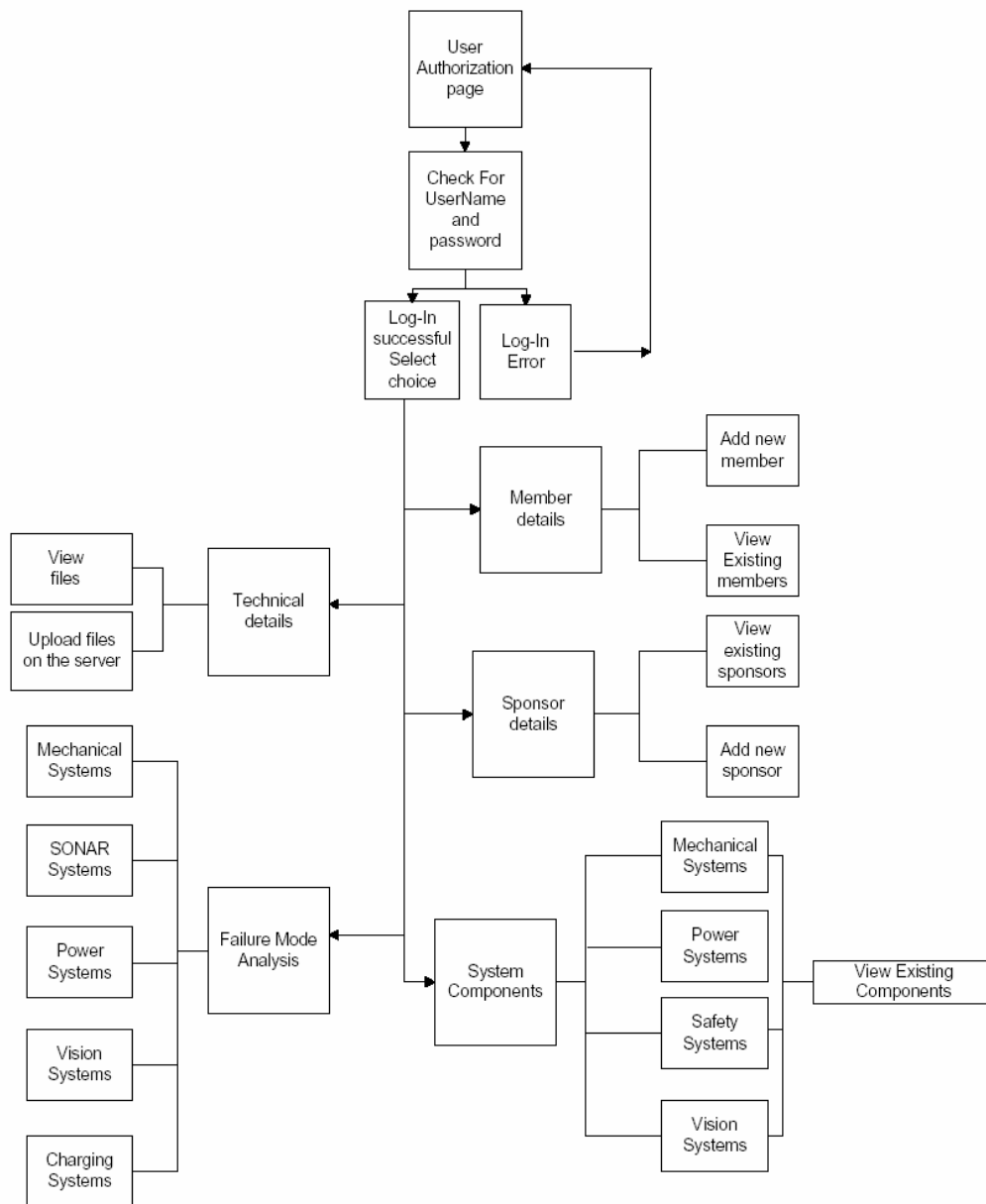

Figure 13 Components of Data Repository

The data repository is designed to store information on the various components of the AGV, current member details, sponsor details and other technical details that are relevant to the user. The data are stored in the form of tables. The database is created as a shared access folder so that it can be accessed and used all over the world. MS Access was used to create the database tables. Once the database is created it is necessary to establish a link in and out of the database so that the tables can be read and accessed. The project provides an interface for the users to add, modify and view the data. This is accomplished by the forms in ASP.NET.

The Application program has a user authentication for data security. It has different levels of security built into it. It has a regular user account which can only view and read data, and not modify any data. Any user authenticated and who can login to the system is a user who can view all information. A special type of user, can be called the power-user, is a user who has all authorities with respect to the data in the application system. He has privileges to add, modify and delete data from the application.

The Application is subdivided into different modules. Each module branches out from the main application into specific modules. Once the user logs on to the system he is taken to a selection page, where he is let to choose a specific module using hyperlinks or image-links. Once the user clicks on the hyper link he is taken to the module. Here he has all information about the module. Depending upon the type of user, he is given different privileges to either only read the data or add. Modify and delete data from the database.

The user authentication is maintained for the whole project, which implies that a user can not just enter the application system with-out formally logging on into the system. If he tries to access any module without logging in, he is automatically taken to the authentication screen.

Different Modules in the Data Repository

The Schematic Diagram of the Data Repository also shows the different modules, mentioned in the previous section. They are

1. Member Details
2. Sponsor Details
3. System Components
4. Failure Modes

5. Technical Details

Every module mentioned in the Diagram captures specific information displayed in a table format and the data is inputted using forms. Except for the Technical details, where the data is stored in to form of files. Here the regular user is allowed to download the files, but not given privileges to upload or delete files, which a power-user enjoys.

Login Screen

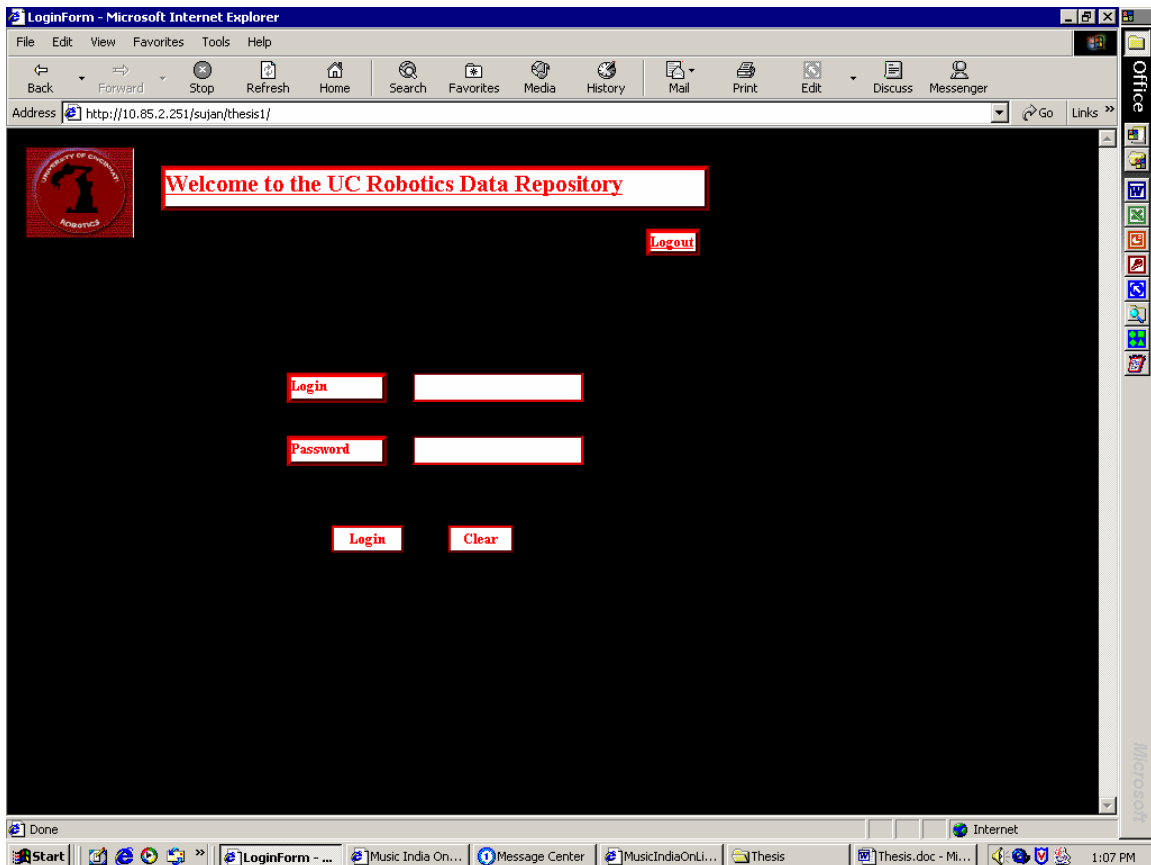

Figure 14 Login Screen Shot

The above figure shows the Login screen. This is the first screen, which comes up when the project is opened. Here the user is checked for authentication and given the privileges (user/administrator) and this is carried out through out the system.

Selection Page

The figure below shows the Selection window. It displays the different modules in the System and allows the user to move to the specific module . This can be thought out as a navigational tool bar.

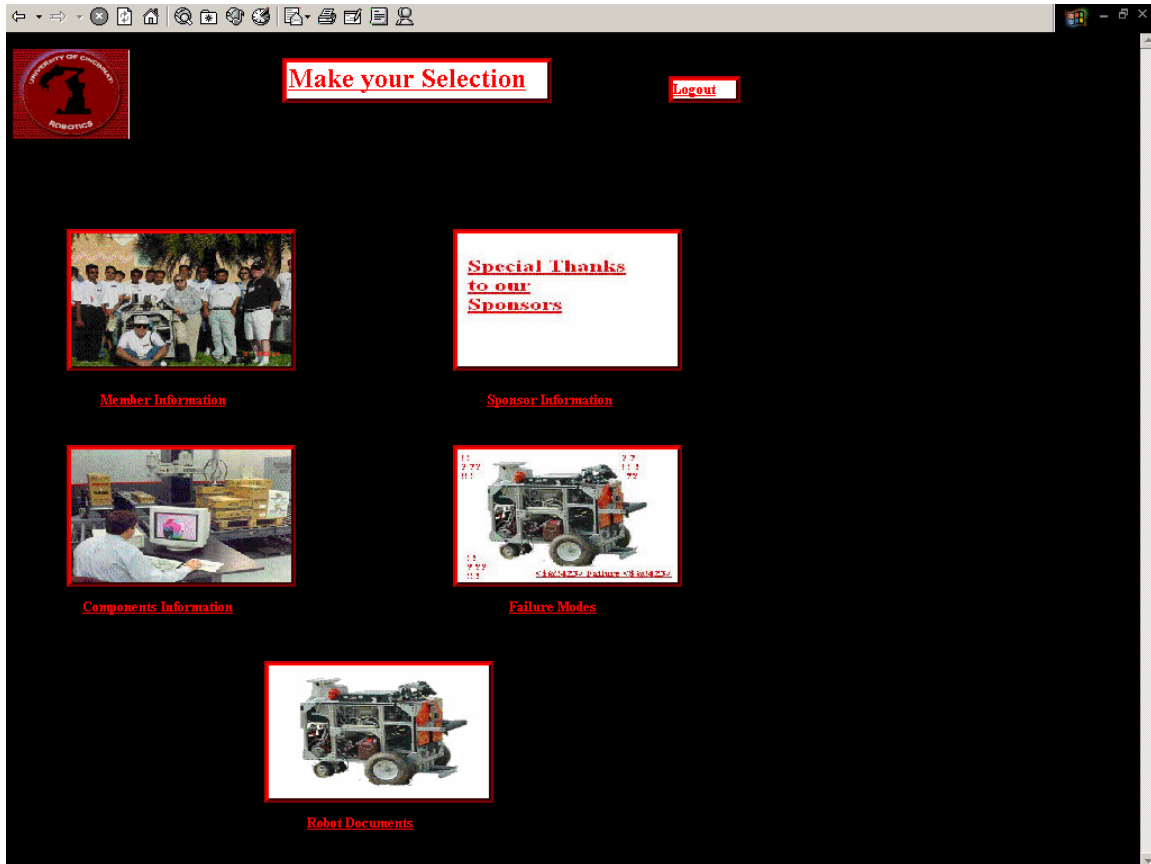

Figure 15 Selection Page Screen

Member Details

The screenshot shows the UC Robotics Team Member Information Administrator interface. At the top left is the University of Cincinnati Robotics logo. The main title is "UC Robotics Team Member Information" with a "Logout" button to its right. Below the title is a table listing four members. Below the table is a form for editing the member with ID "M0001". The form includes fields for L Name, F Name, Street, City, State, Zip, Telephone, and Email, along with "Add", "Modify", "Delete", and "Clear" buttons.

Member_ID	Last_Name	First_Name	Street_Address	City	State	Zip	Telephone	E-Mail
M0001	Balachandran	Sujan	2900 Vine Street	Cincinnati	OH	45219	513-751-6948	balachs@email.uc.edu
M0002	Narayanan	Sugan	2930 Scioto Street	Cincinnati	OH	45219	513-556-7441	Sugan@hotmail.com
M0003	mani	sudha	1562 Worthington st	columbus	ohio	43201	614-291-2915	mani.10@osu.edu
M0004	Ghaffari	Masoud	-	-	-	-	-	-

MemberID: M0001

L Name: Balachandran State: OH

F Name: Sujan Zip: 45219

Street: 2900 Vine Street Telephone: 513-751-6948

City: Cincinnati Email: balachs@email.uc.edu

Buttons: Add, Modify, Delete, Clear

Figure 16 Administrator Screen for Member Information

This screenshot shows the UC Robotics Team Member Information User interface. It is identical to the administrator screen, displaying the same table of member information and the same logo and title.

Member_ID	Last_Name	First_Name	Street_Address	City	State	Zip	Telephone	E-Mail
M0001	Balachandran	Sujan	2900 Vine Street	Cincinnati	OH	45219	513-751-6948	balachs@email.uc.edu
M0002	Narayanan	Sugan	2930 Scioto Street	Cincinnati	OH	45219	513-556-7441	Sugan@hotmail.com
M0003	mani	sudha	1562 Worthington st	columbus	ohio	43201	614-291-2915	mani.10@osu.edu
M0004	Ghaffari	Masoud	-	-	-	-	-	-

Logout

Figure 17 User Screen for Member Information

This module captures all the information about the members of the UC Robotics team that is necessary for immediate communication. The two levels of security can be seen from the two

figures above. In the Administrator Screen the form to Add, Modify and Delete data from the database can be seen, where as in the User Screen the interface only provides the reading option.

Sponsor Details

Here the information of all the Sponsors for the UC Robotics team is stored and updated. This can be used as a ready reckoned, while mailing out letters for support. This also has the same two levels of security of Administrator and Users. The figures that follow show how they have been implemented.

The two levels of security are implemented in all the modules since modification rights of the database can not be given to all users, which might litter the database.

UC Robotics Team Sponsor Information Logout

Sponsor_ID	Last_Name	First_Name	Street_Address	City	State	Zip	Telephone	E-Mail	Amount	Year
S0001	Hall	Ernie	-	-	-	-	-	ernie.hall@uc.edu	1000	2002

SponsorID: S0001

L Name: Hall Zip: -

F Name: Ernie Telephone: -

Street: - Email: ernie.hall@uc.edu

City: - Amount: 1000

State: - Year: 2002

Figure 18 Administrator Screen for Sponsor Information

UC Robotics Team Sponsor Information										
Sponsor_ID	Last_Name	First_Name	Street_Address	City	State	Zip	Telephone	E-Mail	Amount	Year
S0001	Hall	Ernie	-	-	-	-	-	ernie.hall@uc.edu	1000	2002

Figure 19 User Screen shot for Sponsor Information

System Components

This module can be used to store and retrieve information about the Robots components. This is essentially an online catalog of all the parts in the Bearcat III.

UC Robotics Team Robot Component Information

Logout

Part_ID	Part_Name	Vendor	Cost	Quantity	Uses	Subsystems
C0001	Camera	panasonic	3000	3	Line following	Vision System

PartID: C0001

Part Name: Camera Quantity: 3

Vendor Name: panasonic Uses: Line following

Cost: 3000 Subsystems: Vision System

Add Modify Delete

Figure 20 Administrator Screen for Component Information

UC Robotics Team Robot Component Information

Logout

Part_ID	Part_Name	Vendor	Cost	Quantity	Uses	Subsystems
C0001	Camera	panasonic	3000	3	Line following	Vision System

Figure 21 User Screen for Component Information

Failure Modes

This module is an extension to the previous one, in the sense that this stores information about the components. Here is where all the failure modes of the different components can be stored.

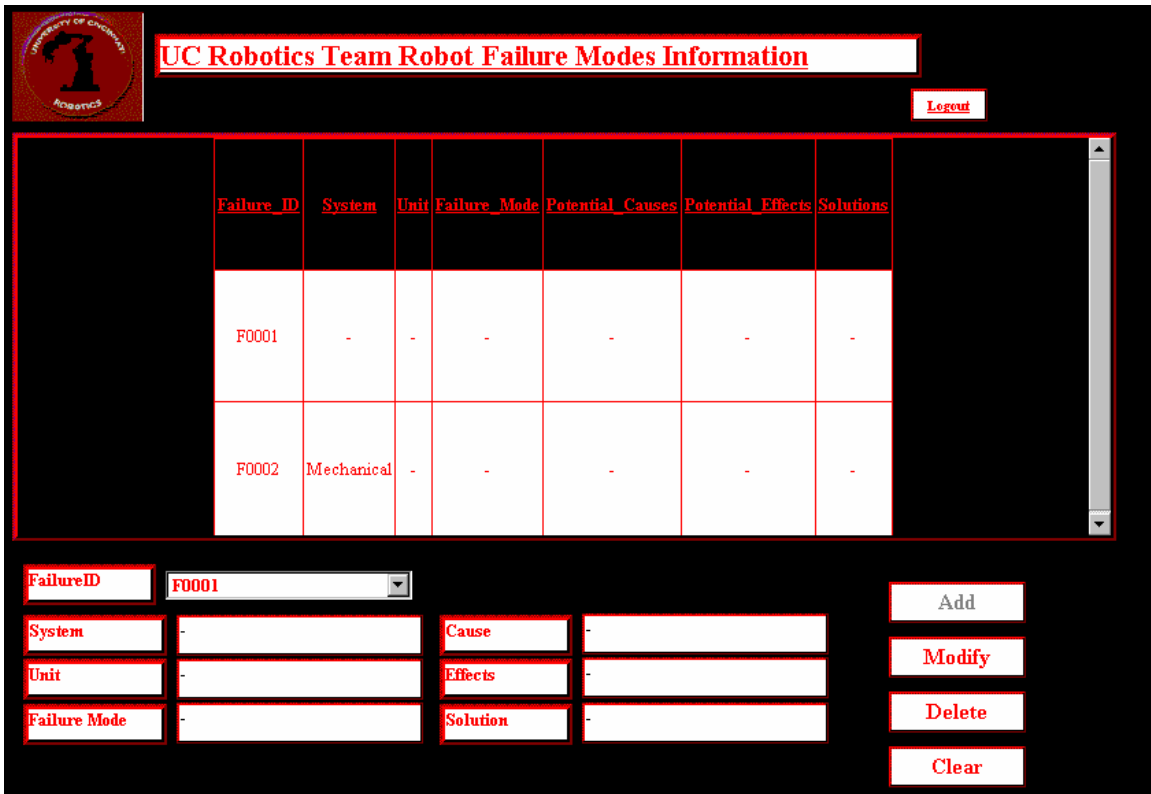

Figure 22 Administrator Screen for Failure Modes

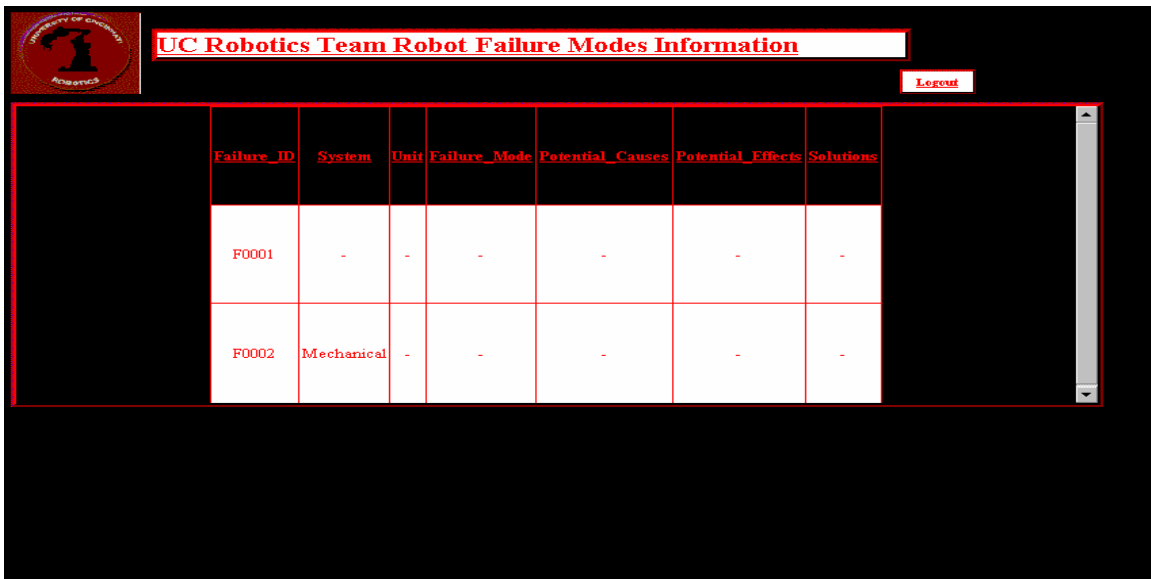

Figure 23 User Screen for Failure Modes

Technical Details

This module is different from all other modules. This serves as a good interface for file sharing. The UC Robotics team has a lot of information as files from various presentations as power-point files word documents, scanned information from their product catalogs etc. This module can be

helpful to store such files in the server without the use of the database, since using database for such an application would slowdown the system.

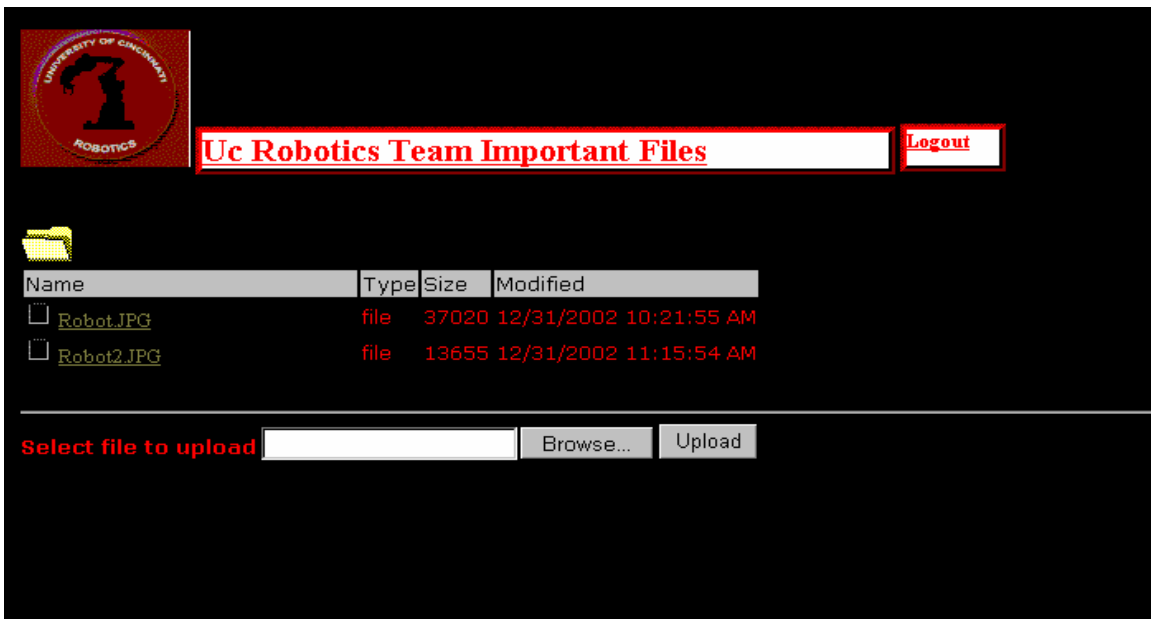

Figure 24 Administrator Screen for Technical Details

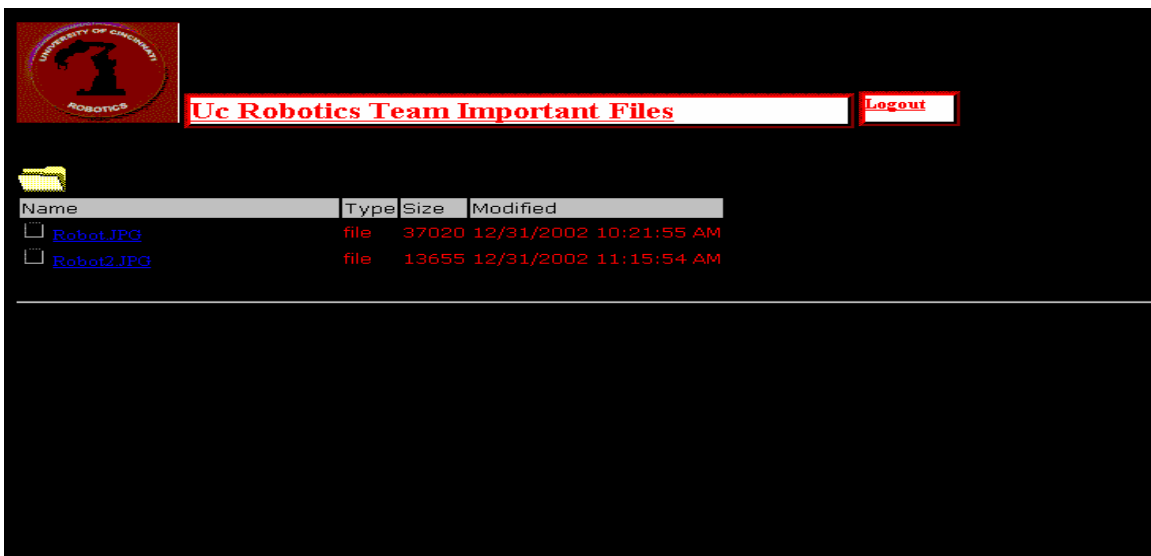

Figure 25 User Screen for Technical Details

Chapter 7

Conclusions and Recommendations

A data repository is valuable in terms of centralization of information and pulling out when required. It is a very useful tool when it comes to sharing of information without any time delay. Data repositories can be used not only for storing text and numeric data, but also for picture images and files. Though the project faces limitation in storing huge files, it does demonstrate how it can be achieved. It can be carried out in a much safe way if full scale corporate databases like Oracle are used to store data.

Since data repositories need to be updated at regular intervals to stay current, care should be taken to ensure that data redundancy is avoided at all times. However, this is only at the logical level, at the physical level there is no redundancy. So at the design level there must be little problem because of data-redundancy. So make the application run more efficiently it is good to avoid data redundancy. This no doubt will be a very useful develops a tool that can accomplish this task. Another way to ensure this is by designing the system in such a way that the data are not manipulated except by the administrator or by the database manager. Stringent validation techniques should be implemented to ensure that there are no violations to this rule.

References

Text

1. Curt Simmons, Ash Rofail, "The Microsoft .NET Platforms and Technologies", Prentice Hall, New Jersey, 2002.
2. Fred R. McFadden, Jeffrey A. Hoffer, Mary B. Prescott, "Modern Database Management", Sixth Edition, Addison-Wesley, New York, 2002.
3. Jeffrey A. Hoffer, Joey F. George, Joseph S. Valacich, "Modern Systems Analysis and Design", Second Edition, Addison-Wesley, New York, 1998.
4. Ramya Ravindran, "DataMart for an Autonomous Guided Vehicle using ColdFusion", 2001.
5. Rob Birdwell, Ollie Cornes, Chris Goode, Ajoy Krishnamoorthy, Juan T. Llibre, Christopher L. Miller, Neil Raybould, David Sussman, Chris Ullman, "Beginning ASP.NET using VB.NET", First Edition, Wrox Press, United Kingdom, 2001.
6. Aktas, A.Z., "Structured Analysis and Design of Information Systems.", Englewood Cliffs, Prentice Hall, New Jersey, 1987.
7. Mumford, E., "Participative Systems Design: A Structure and Method.", Systems, Objectives, Solutions 1 (1):5-10, 1981.
8. Lakhanpal, B., "Understanding the Factors Influencing the Performance of Software Development Groups: An Explanatory Analysis.", Information and Software Technology 35(8): 468-73, 1993.
9. Butler, J., "Automating Process trims Software Development Fat.", Software Magazine 14(8) (Aug) :37-46, 1994.
10. Bruce, T., J. Fuller, and T. Moriarty, "So You Want a Repository", Database Programming and Design 2(May): 60-69, 1989.
11. Nunamaker, J.F., "Build and Learn, Evaluate and Learn", Informatica 1(1):1-6, 1992.
12. IBM., "Business Systems Planning." IN Advanced Systems Development/Feasibility Techniques, edited by J.D. Couger, M.A. Colter, and R.W. Knapp, New York, Wiley: 236-314, 1982.

13. Parker, M.M., and R.J. Benson, "Enterprise Information Management: State-of-the-Art Strategic Planning.", *Journal for Information Systems Management* 6(Summer):14-23, 1989.
14. Radosevich, L. "Can You Measure Web ROI?", *Datamation*, July:92-96, 1989.
15. Davenport, T.H. "Process Innovation: Reengineering Work Through Information Technology", Boston, MA: Harvard Business School Press, 1993.
16. DeMarco, T., "Structured Analysis and System Specification."Engelwood Cliffs, Prentice Hall, NJ, 1979.

Web

1. <http://www.robotics.uc.edu/IGVC2002/DesignReport/>
2. <http://www.w3schools.com/>
3. <http://www.asp.net/Default.aspx?tabindex=0&tabid=1>
4. <http://msdn.microsoft.com/vbasic/>
5. <http://www.gotdotnet.com/team/vb/>

Appendix

Project Code

Login Form

```
<%@Import Namespace="System.Data.OleDb"%>
<%@Import Namespace="System.Data"%>
<%@ Page Language="vb" %>
<!DOCTYPE HTML PUBLIC "-//W3C//DTD HTML 4.0 Transitional//EN">
<HTML>
  <HEAD>
    <title>LoginForm</title>
    <script runat="server">
      Sub GenClear()
        TextBoxLogin.Text = ""
        TextBoxPassword.Text = ""
        TextBoxError.text = ""
        TextBoxError.Visible=False
      end Sub

      sub Login (S as object, E as EventArgs)
        dim test as Integer
        dim strconn as string="Provider=Microsoft.Jet.Oledb.4.0; data
source=F:\wwwroot\sujan\thesis1\Thesis1.mdb"
        dim conn as new OleDbConnection(strconn)
        conn.open()
        dim strSQL as string="select User_Name, Password, Security_Level from Login where
User_name=? and Password=?"
        Dim ObjCommand as New OleDbCommand(strSQL,conn)
        objcommand.parameters.add("@User_Name",OleDbType.VarWchar).value=TextBoxLogin.Text
        objcommand.parameters.add("@Password",OleDbType.VarWchar).value=TextBoxPassword.Text

        Dim objdatareader as OleDbDataReader
        objDatareader=objcommand.executereader()

        While objdatareader.read()
          test=1
          Session("Log")=objdatareader("Security_Level")
          'response.write("Correct Login")
        end while
        if test=1 then
          response.redirect("http://10.85.2.251/sujan/thesis1/Selection.aspx")
          'MessageBox.Show("Login Correct !", "Login Info",
MessageBoxButtons.OK,MessageBoxIcon.Exclamation )
        else
          'MessageBox.Show("Login Incorrect !", "Login Info",
MessageBoxButtons.OK,MessageBoxIcon.Exclamation)
          call GenClear()
          'call clear
          TextBoxError.Visible=true
          TextBoxError.Text="Invalid Login! Please Try again."
        end if
        objdatareader.close()
        conn.close()
      end sub
      sub Clear (S1 as object, E1 as EventArgs)
        call GenClear()
      end sub
    </script>
  </HEAD>
  <BODY>
    <div style="text-align:center">
      <input type="text" value="" id="txtLogin" />
      <input type="password" value="" id="txtPassword" />
      <input type="button" value="Login" />
      <input type="button" value="Clear" />
    </div>
    <div style="text-align:center" id="divError">
      <input type="text" value="" />
    </div>
  </BODY>
</HTML>
```

```

Session.abandon()
end Sub
</script>
<meta content="Microsoft Visual Studio.NET 7.0" name="GENERATOR">
<meta content="Visual Basic 7.0" name="CODE_LANGUAGE">
<meta content="JavaScript" name="vs_defaultClientScript">
<meta content="http://schemas.microsoft.com/intellisense/ie5"
name="vs_targetSchema">
</HEAD>
<body bgColor="#000000" MS_POSITIONING="GridLayout">
<form id="Form1" method="post" runat="server">
<asp:label id="LabelLogin" style="Z-INDEX: 101; LEFT: 248px; POSITION:
absolute; TOP: 216px" runat="server" Font-Bold="True" BorderStyle="Outset" Height="27" Width="89"
ForeColor="Red" BorderColor="Red" BackColor="White">Login</asp:label><asp:label
id="LabelPassword" style="Z-INDEX: 102; LEFT: 248px; POSITION: absolute; TOP: 272px"
runat="server" Font-Bold="True" BorderStyle="Outset" Height="27" Width="89" ForeColor="Red"
BorderColor="Red" BackColor="White">Password</asp:label><asp:textbox id="TextBoxLogin"
style="Z-INDEX: 103; LEFT: 360px; POSITION: absolute; TOP: 216px" tabIndex="10" runat="server"
BorderStyle="Inset" Height="26px" Width="152px" Font-Size="Larger"
BorderColor="Red"></asp:textbox><asp:textbox id="TextBoxPassword" style="Z-INDEX: 104; LEFT:
360px; POSITION: absolute; TOP: 272px" tabIndex="20" runat="server" BorderStyle="Inset"
Height="26" Width="152px" Font-Size="Larger" TextMode="Password"
BorderColor="Red"></asp:textbox><asp:button id="ButtonLogin" style="Z-INDEX: 105; LEFT: 288px;
POSITION: absolute; TOP: 352px" onclick="Login" tabIndex="30" runat="server" Font-Bold="True"
BorderStyle="Outset" Height="24px" Width="64px" Text="Login" ForeColor="Red" BorderColor="Red"
BackColor="White" Font-Names="Times New Roman"></asp:button><asp:button id="ButtonClear"
style="Z-INDEX: 106; LEFT: 392px; POSITION: absolute; TOP: 352px" onclick="Clear" tabIndex="40"
runat="server" Font-Bold="True" BorderStyle="Outset" Height="24" Width="58px" Text="Clear"
ForeColor="Red" BorderColor="Red" BackColor="White" Font-Names="Times New
Roman"></asp:button><asp:textbox id="TextBoxError" style="Z-INDEX: 107; LEFT: 136px; POSITION:
absolute; TOP: 144px" runat="server" Font-Bold="True" BorderStyle="None" Height="32px"
Width="456px" Font-Size="Medium" ForeColor="Red" Visible="False" Font-Underline="True"
BackColor="Black"></asp:textbox><asp:linkbutton id="LBLogOut" style="Z-INDEX: 108; LEFT: 568px;
POSITION: absolute; TOP: 88px" onclick="Clear" runat="server" Font-Bold="True"
BorderStyle="Outset" Height="24px" Width="48px" ForeColor="Red" BorderColor="Red"
BackColor="White">Logout</asp:linkbutton>
<asp:Label id="Label1" style="Z-INDEX: 109; LEFT: 136px; POSITION:
absolute; TOP: 32px" runat="server" Font-Bold="True" BorderStyle="Outset" Height="40px"
Width="488px" Font-Size="Large" ForeColor="Red" BorderColor="Red" BackColor="White" Font-
Names="Times New Roman" Font-Underline="True">Welcome to the UC Robotics Data
Repository</asp:Label>
<asp:Image id="Image1" style="Z-INDEX: 110; LEFT: 16px; POSITION:
absolute; TOP: 16px" runat="server" Width="96px" Height="80px"
ImageUrl="title_Links.gif"></asp:Image></form>
</body>
</HTML>

```

Selection Form

```

<% @ Page Language="vb"%>
<!DOCTYPE HTML PUBLIC "-//W3C//DTD HTML 4.0 Transitional//EN">
<HTML>
<HEAD>
<title>WebForm2</title>
<meta content="Microsoft Visual Studio.NET 7.0" name="GENERATOR">
<meta content="Visual Basic 7.0" name="CODE_LANGUAGE">
<meta content="JavaScript" name="vs_defaultClientScript">
<meta content="http://schemas.microsoft.com/intellisense/ie5"
name="vs_targetSchema">

```

```

                <SCRIPT language="vb" runat="server">
Sub Page_Load()
If Session("Log") = "A" OR Session("Log")= "U" then
response.write(Session("Log"))
LabelLogin.Visible=False
Else
ButtonLogin.Visible=True
ButtonLogout.Visible=False
LabelLogin.Text="Please Log in before making a selection"
End if
End Sub
Sub IBMember(S As Object, E As ImageClickEventArgs)
response.redirect("http://10.85.2.251/sujan/thesis1/Member.aspx")
End Sub
Sub IBSponsor(S As Object, E As ImageClickEventArgs)
response.redirect("http://10.85.2.251/sujan/thesis1/Sponsor.aspx")
End Sub
Sub IBComponents(S As Object, E As ImageClickEventArgs)
response.redirect("http://10.85.2.251/sujan/thesis1/Components.aspx")
End Sub
Sub IBFailure(S As Object, E As ImageClickEventArgs)
response.redirect("http://10.85.2.251/sujan/thesis1/Failure.aspx")
End Sub
Sub IBFiles(S As Object, E As ImageClickEventArgs)
response.redirect("http://10.85.2.251/sujan/thesis1/Files.aspx")
End Sub
Sub MLogout(S As Object, E As EventArgs)
Session.abandon()
response.redirect("http://10.85.2.251/sujan/thesis1/FrmLogin.aspx")
End Sub
Sub BLogin(S As Object, E As EventArgs)
response.redirect("http://10.85.2.251/sujan/thesis1/FrmLogin.aspx")
End Sub
                </SCRIPT>
</HEAD>
<body bgColor="#000000" MS_POSITIONING="GridLayout">
    <form id="Form1" method="post" runat="server">
        <asp:imagebutton id="ButtonMember" style="Z-INDEX: 100; LEFT: 56px;
POSITION: absolute; TOP: 176px" onclick="IBMember" runat="server" Width="196px" Height="118px"
BackColor="White" BorderStyle="Outset" BorderWidth="1mm" BorderColor="Red" AlternateText="UC
Robotics Team member Information" ForeColor="Red" ImageUrl="250team3.jpg"></asp:imagebutton>
        <asp:hyperlink id="Hyperlink1" style="Z-INDEX: 115; LEFT: 270px;
POSITION: absolute; TOP: 696px" runat="server" ForeColor="Red" Height="24px" Width="128px"
NavigateUrl="http://10.85.2.251/sujan/thesis1/Files.aspx" Font-Bold="True">Robot
Documents</asp:hyperlink>
        <asp:imagebutton id="buttonFiles" style="Z-INDEX: 114; LEFT: 232px;
POSITION: absolute; TOP: 560px" onclick="IBFiles" runat="server" ImageUrl="Robot.JPG"
BackColor="Red" BorderWidth="1mm" BorderStyle="Outset" BackColor="White" Height="118px"
Width="196px"></asp:imagebutton><asp:image id="Image1" style="Z-INDEX: 113; LEFT: 8px;
POSITION: absolute; TOP: 16px" runat="server" Width="104px" Height="80px"
ImageUrl="title_Links.gif"></asp:image><asp:hyperlink id="HLFailure" style="Z-INDEX: 112; LEFT:
450px; POSITION: absolute; TOP: 504px" runat="server" Width="104px" Height="24px"
ForeColor="Red" Font-Bold="True" NavigateUrl="http://10.85.2.251/sujan/thesis1/Failure.aspx">Failure
Modes</asp:hyperlink><asp:hyperlink id="HLComponents" style="Z-INDEX: 110; LEFT: 70px;
POSITION: absolute; TOP: 504px" runat="server" Width="176px" Height="24px" ForeColor="Red" Font-
Bold="True" NavigateUrl="http://10.85.2.251/sujan/thesis1/Components.aspx">Components
Information</asp:hyperlink><asp:hyperlink id="HLSponsor" style="Z-INDEX: 107; LEFT: 430px;
POSITION: absolute; TOP: 320px" runat="server" Width="144px" Height="24px" ForeColor="Red" Font-

```



```

Bold="True" NavigateUrl="http://10.85.2.251/sujan/thesis1/Sponsor.aspx">Sponsor
Information</asp:hyperlink><asp:imagebutton id="ButtonFailure" style="Z-INDEX: 103; LEFT: 400px;
POSITION: absolute; TOP: 368px" onclick="IBFailure" runat="server" Width="196px" Height="118px"
BackColor="White" BorderStyle="Outset" BorderWidth="1mm" BorderColor="Red"
ImageUrl="Robot2.JPG"></asp:imagebutton><asp:imagebutton id="ButtonComponents" style="Z-
INDEX: 102; LEFT: 56px; POSITION: absolute; TOP: 368px" onclick="IBComponents" runat="server"
Width="196px" Height="118px" BackColor="White" BorderStyle="Outset" BorderWidth="1mm"
BorderColor="Red" ImageUrl="palleizer.jpg"></asp:imagebutton><asp:imagebutton id="ButtonSponsor"
style="Z-INDEX: 101; LEFT: 400px; POSITION: absolute; TOP: 176px" onclick="IBSponsor"
runat="server" Width="196px" Height="118px" BackColor="White" BorderStyle="Outset"
BorderWidth="1mm" BorderColor="Red" ImageUrl="Robot1.JPG"></asp:imagebutton>&nbsp;
<asp:textbox id="TextBox1" style="Z-INDEX: 104; LEFT: 248px; POSITION:
absolute; TOP: 24px" runat="server" Width="240px" Height="40px" BorderStyle="Outset"
BorderWidth="1mm" BorderColor="Red" ForeColor="Red" Font-Bold="True" Font-Underline="True"
Font-Names="Times New Roman" Font-Size="Large">Make your Selection</asp:textbox><asp:hyperlink
id="HLMember" style="Z-INDEX: 105; LEFT: 86px; POSITION: absolute; TOP: 320px" runat="server"
Width="144px" Height="24px" ForeColor="Red" Font-Bold="True"
NavigateUrl="http://10.85.2.251/sujan/thesis1/Member.aspx">Member
Information</asp:hyperlink><asp:linkbutton id="ButtonLogout" style="Z-INDEX: 106; LEFT: 592px;
POSITION: absolute; TOP: 40px" onclick="MLogout" runat="server" Width="64px" Height="24px"
BackColor="White" BorderStyle="Outset" BorderColor="Red" ForeColor="Red" Font-
Bold="True">Logout</asp:linkbutton><asp:label id="LabelLogin" style="Z-INDEX: 108; LEFT: 160px;
POSITION: absolute; TOP: 96px" runat="server" Width="408px" Height="40px" BackColor="Black"
BorderColor="Red" ForeColor="Red" Font-Bold="True" Font-Size="Large"></asp:label><asp:linkbutton
id="ButtonLogin" style="Z-INDEX: 109; LEFT: 600px; POSITION: absolute; TOP: 96px"
onclick="BLogin" runat="server" Width="56px" Height="24px" BackColor="White"
BorderStyle="Outset" BorderColor="Red" ForeColor="Red" Font-Bold="True"
Visible="False">Login</asp:linkbutton></form>
</body>
</HTML>

```

Member Form

```

<% @ Page Language="vb" %>
<% @ Import Namespace="System.Data" %>
<% @ Import Namespace="System.Data.OleDb" %>
<!DOCTYPE HTML PUBLIC "-//W3C//DTD HTML 4.0 Transitional//EN">
<HTML>
  <HEAD>
    <title>Member</title>
    <script language="vb" runat="server">
      Sub AddPL()
        Dim ObjDataset as New Dataset()
        Dim StrConnection as string = "provider=Microsoft.Jet.OLEDB.4.0;Data Source =
f:\wwwroot\sujan\thesis1\thesis1.mdb"
        Dim StrSQL as String = "Select * from Member_Information"
        Dim ObjConnection as New OleDbConnection(StrConnection)
        Dim ObjAdapter as New OleDbDataAdapter(StrSQL, ObjConnection)
        ObjAdapter.Fill(ObjDataset,"Member_Information")
        Dim ObjView as New DataView(ObjDataset.Tables("Member_Information"))

        Dim ObjCommand as New OleDbCommand(StrSQL,ObjConnection)
        ObjConnection.open()
        DGMember.DataSource = ObjView
        DGMember.DataBind()
        DDMemberID.DataSource = ObjView
        DDMemberID.DataMember = "Member_ID"
        DDMemberID.DataValueField = "Member_ID"
        DDMemberID.DataBind()

```

```

Dim ObjRow as datarow = ObjDataset.Tables("Member_Information").Rows(0)
TextBoxMLName.Text=ObjRow.Item("Last_Name")
TextBoxMFName.Text=ObjRow.Item("First_Name")
TextBoxMStreet.Text=ObjRow.Item("Street_Address")
TextBoxMCity.Text=ObjRow.Item("City")
TextBoxMState.Text=ObjRow.Item("State")
TextBoxMZip.Text=ObjRow.Item("Zip")
TextBoxMPhone.Text=ObjRow.Item("Telephone")
TextBoxMEmail.Text=ObjRow.Item("E-Mail")
TextBoxTemp2.Text=ObjRow.Item("Member_ID")
End Sub

Sub Page_Load()
If Session("Log")="A" OR Session("Log")= "U" then

Dim ObjDataset as New Dataset()
Dim StrConnection as string = "provider=Microsoft.Jet.OLEDB.4.0;Data Source =
f:\wwwroot\sujan\thesis1\thesis1.mdb"
Dim StrSQL as String = "Select * from Member_Information"
Dim ObjConnection as New OleDbConnection(StrConnection)
Dim ObjAdapter as New OleDbDataAdapter(StrSQL, ObjConnection)
ObjAdapter.Fill(ObjDataset,"Member_Information")
Dim ObjView as New DataView(ObjDataset.Tables("Member_Information"))

'Dim ObjCommand as New OleDbCommand(StrSQL,ObjConnection)
ObjConnection.open()
if not ispostback then
DGMemb er.DataSource = ObjView
DGMemb er.DataBind()

DDMemberID.DataSource = ObjView
DDMemberID.DataMember = "Member_ID"
DDMemberID.DataValueField = "Member_ID"
DDmemberID.DataBind()
Dim ObjRow as datarow = ObjDataset.Tables("Member_Information").Rows(0)
TextBoxMLName.Text=ObjRow.Item("Last_Name")
TextBoxMFName.Text=ObjRow.Item("First_Name")
TextBoxMStreet.Text=ObjRow.Item("Street_Address")
TextBoxMCity.Text=ObjRow.Item("City")
TextBoxMState.Text=ObjRow.Item("State")
TextBoxMZip.Text=ObjRow.Item("Zip")
TextBoxMPhone.Text=ObjRow.Item("Telephone")
TextBoxMEmail.Text=ObjRow.Item("E-Mail")
TextBoxTemp2.Text=ObjRow.Item("Member_ID")
ButtonMAdd.Enabled=False
end if

ObjConnection.Close()
If Session("Log")<>"A" then
DDMemberID.Visible=False
TextBoxMFName.Visible=False
TextBoxMLName.Visible=False
TextBoxMStreet.Visible=False
TextBoxMCity.Visible=False
TextBoxMState.Visible=False
TextBoxMZip.Visible=False
TextBoxMPhone.Visible=False
TextBoxMEmail.Visible=False

```

```

LabelMID.Visible=False
LabelMFName.Visible=False
LabelMLName.Visible=False
LabelMStreet.Visible=False
LabelMCity.Visible=False
LabelMState.Visible=False
LabelMZip.Visible=False
LabelMPhone.Visible=False
LabelMEmail.Visible=False
ButtonMAdd.Visible=False
ButtonMModify.Visible=False
ButtonMDelete.Visible=False
ButtonMClear.Visible=False
End If
Else
response.redirect("http://10.85.2.251/sujan/thesis1/FrmLogin.aspx")
End IF
End Sub

Sub DDMember_IDSelect( S1 as Object, E1 as EventArgs)
Dim ObjDataset as New Dataset()
Dim StrConnection as string = "provider=Microsoft.Jet.OLEDB.4.0;Data Source =
f:\wwwroot\sujan\thesis1\thesis1.mdb"
Dim ObjConnection as New OleDbConnection(StrConnection)
Dim strSQL as String = "Select * from Member_Information where " & "Member_ID = " &
DDMemberID.SelectedItem.value & " ' "
Dim ObjAdapter as New OleDbDataAdapter(StrSQL, ObjConnection)
ObjAdapter.Fill(ObjDataset,"Member_Information")
Dim ObjRow as DataRow = ObjDataset.Tables("Member_Information").Rows(0)
TextBoxMLName.Text=ObjRow.Item("Last_Name")
TextBoxMFName.Text=ObjRow.Item("First_Name")
TextBoxMStreet.Text=ObjRow.Item("Street_Address")
TextBoxMCity.Text=ObjRow.Item("City")
TextBoxMState.Text=ObjRow.Item("State")
TextBoxMZip.Text=ObjRow.Item("Zip")
TextBoxMPhone.Text=ObjRow.Item("Telephone")
TextBoxMEmail.Text=ObjRow.Item("EMail")
TextBoxTemp2.text=ObjRow.Item("Member_ID")
ObjConnection.Close()
ButtonMAdd.Enabled=False
End Sub

Sub MAdd( S as Object, E As EventArgs)
Dim ObjDataset as New Dataset()
Dim StrConnection as string = "provider=Microsoft.Jet.OLEDB.4.0;Data Source =
f:\wwwroot\sujan\thesis1\thesis1.mdb"
Dim ObjConnection as New OleDbConnection(StrConnection)
Dim strSQL as String = "Select Member_ID from Member_Information"
Dim ObjAdapter as New OleDbDataAdapter(StrSQL, ObjConnection)
ObjConnection.Open()
ObjAdapter.Fill(ObjDataset,"Member_ID")
Dim ObjRow as DataRow =
ObjDataset.Tables("Member_ID").Rows(ObjDataset.Tables("Member_ID").Rows.Count - 1)
Dim TempID as String = ObjRow.Item("Member_ID")
Dim TempID1 as string = Right(TempID, 4)
Dim ITempID as Integer = Cint(TempID1)+1
Dim TempID2 as String
If ITempID < 10 Then

```

```

TempID2 ="M000" + cstr(ITempID)
Else If ITempID < 100 Then
TempID2 ="M00" + cstr(ITempID)
Else If ITempID < 1000 Then
TempID2 ="M0" + cstr(ITempID)
Else
TempID2 ="M" + cstr(ITempID)
End IF
TextBoxTemp.Text = TempID2
If TextBoxMLName.Text="" then
TextBoxMLName.Text="-"
end if
If TextBoxMFName.Text="" then
TextBoxMFName.Text="-"
end if
If TextBoxMStreet.Text="" then
TextBoxMStreet.Text="-"
end if
If TextBoxMCity.Text="" then
TextBoxMCity.Text="-"
end if
If TextBoxMState.Text="" then
TextBoxMState.Text="-"
end if
If TextBoxMZip.Text="" then
TextBoxMZip.Text="-"
end if
If TextBoxMPhone.Text="" then
TextBoxMPhone.Text="-"
end if
If TextBoxMEMail.Text="" then
TextBoxMEMail.Text="-"
end if
 strSql = " Insert into `Member_Information`
(Member_ID`,`Last_Name`,`First_Name`,`Street_Address`,`City`,`State`,`Zip`,`Telephone`,`E-Mail`)" &
-
" Values (" & _
"" & TextBoxTemp.Text & "," & _
"" & TextBoxMLName.Text & "," & _
"" & TextBoxMFName.Text & "," & _
"" & TextBoxMStreet.Text & "," & _
"" & TextBoxMCity.Text & "," & _
"" & TextBoxMState.Text & "," & _
"" & TextBoxMZip.Text & "," & _
"" & TextBoxMPhone.Text & "," & _
"" & TextBoxMEMail.Text & ")"
Dim ObjCommand as New OleDbCommand(StrSql,ObjConnection)
ObjCommand.ExecuteNonQuery()
ObjConnection.Close()
Call AddPL()
End Sub

Sub MClear(S as Object, E as EventArgs)
TextBoxMLName.Text=""
TextBoxMFName.Text=""
TextBoxMStreet.Text=""
TextBoxMCity.Text=""
TextBoxMState.Text=""

```

```

    TextBoxMZip.Text=""
    TextBoxMPhone.Text=""
    TextBoxMEmail.Text=""
    ButtonMAdd.Enabled=True
End Sub

Sub MModify(S As Object, E as EventArgs)
    Dim StrConnection as string = "provider=Microsoft.Jet.OLEDB.4.0;Data Source =
f:\wwwroot\sujan\thesis1\thesis1.mdb"
    Dim ObjConnection as New OleDbConnection(StrConnection)
    ObjConnection.Open()
    Dim strSql as String
    strSql = " Update `Member_Information` Set " & _
        "`Last_Name`='" & TextBoxMLName.Text & "','" & _
        "`First_Name`='" & TextBoxMFName.Text & "','" & _
        "`Street_Address`='" & TextBoxMStreet.Text & "','" & _
        "`City`='" & TextBoxMCity.Text & "','" & _
        "`State`='" & TextBoxMState.Text & "','" & _
        "`Zip`='" & TextBoxMZip.Text & "','" & _
        "`Telephone`='" & TextBoxMPhone.Text & "','" & _
        "`E-Mail`='" & TextBoxMEmail.Text & "'" & _
        " Where (`Member_ID`=" & TextBoxTemp2.Text & "')"
    Dim ObjCommand as New OleDbCommand(StrSql,ObjConnection)
    ObjCommand.ExecuteNonQuery()
    ObjConnection.Close()
    Call AddPL()
End Sub

Sub MDelete(S As Object, E as EventArgs)
    Dim StrConnection as string = "provider=Microsoft.Jet.OLEDB.4.0;Data Source =
f:\wwwroot\sujan\thesis1\thesis1.mdb"
    Dim ObjConnection as New OleDbConnection(StrConnection)
    ObjConnection.Open()
    Dim strSql as String
    strSql = "Delete from `Member_Information` where (`Member_ID`=" & TextBoxTemp2.Text &
""")"
    Dim ObjCommand as New OleDbCommand(StrSql,ObjConnection)
    ObjCommand.ExecuteNonQuery()
    ObjConnection.Close()
    Call AddPL()
End Sub

Sub MLogOut(S As Object, E As EventArgs)
    Session.abandon()
    response.redirect("http://10.85.2.251/sujan/thesis1/FrmLogin.aspx")
End Sub

```

```

</script>
<meta content="Microsoft Visual Studio.NET 7.0" name="GENERATOR">
<meta content="Visual Basic 7.0" name="CODE_LANGUAGE">
<meta content="JavaScript" name="vs_defaultClientScript">
<meta content="http://schemas.microsoft.com/intellisense/ie5"
name="vs_targetSchema">
</HEAD>
<body bgColor="#000000" MS_POSITIONING="GridLayout">

```

```

<FORM id="Form1" method="post" runat="server">
  <asp:button id="ButtonLogout" style="Z-INDEX: 123; LEFT: 616px;
POSITION: absolute; TOP: 64px" onclick="MLogout" runat="server" Text="Logout" Font-
Underline="True" Font-Size="Smaller" ForeColor="Red" Font-Names="Times New Roman" Font-
Bold="True" BorderColor="Red" BorderStyle="Outset" BackColor="White" Height="24px"
Width="56px"></asp:button>
  <asp:Image id="Image1" style="Z-INDEX: 128; LEFT: 8px; POSITION:
absolute; TOP: 8px" runat="server" Height="80px" Width="104px"
ImageUrl="title_Links.gif"></asp:Image><asp:button id="ButtonMAdd" style="Z-INDEX: 125; LEFT:
648px; POSITION: absolute; TOP: 424px" onclick="MAdd" tabIndex="90" runat="server" Text="Add"
Font-Size="Larger" ForeColor="Red" Font-Names="Times New Roman" Font-Bold="True"
BorderColor="Red" BorderStyle="Outset" BackColor="White" Height="30px"
Width="100px"></asp:button><asp:button id="ButtonMClear" style="Z-INDEX: 122; LEFT: 648px;
POSITION: absolute; TOP: 544px" onclick="MClear" tabIndex="120" runat="server" Text="Clear" Font-
Size="Larger" ForeColor="Red" Font-Names="Times New Roman" Font-Bold="True"
BorderColor="Red" BorderStyle="Outset" BackColor="White" Height="30px"
Width="100px"></asp:button><asp:button id="ButtonMDelete" style="Z-INDEX: 121; LEFT: 648px;
POSITION: absolute; TOP: 504px" onclick="MDelete" tabIndex="110" runat="server" Text="Delete"
Font-Size="Larger" ForeColor="Red" Font-Names="Times New Roman" Font-Bold="True"
BorderColor="Red" BorderStyle="Outset" BackColor="White" Height="30px"
Width="100px"></asp:button><asp:button id="ButtonMModify" style="Z-INDEX: 120; LEFT: 648px;
POSITION: absolute; TOP: 464px" onclick="MModify" tabIndex="100" runat="server" Text="Modify"
Font-Size="Larger" ForeColor="Red" Font-Names="Times New Roman" Font-Bold="True"
BorderColor="Red" BorderStyle="Outset" BackColor="White" Height="30px"
Width="100px"></asp:button><asp:label id="LabelMCity" style="Z-INDEX: 119; LEFT: 16px;
POSITION: absolute; TOP: 544px" runat="server" ForeColor="Red" Font-Names="Times New Roman"
Font-Bold="True" BorderColor="Red" BorderStyle="Outset" BackColor="White" Height="30px"
Width="97px">City</asp:label><asp:label id="LabelMStreet" style="Z-INDEX: 118; LEFT: 16px;
POSITION: absolute; TOP: 512px" runat="server" ForeColor="Red" Font-Names="Times New Roman"
Font-Bold="True" BorderColor="Red" BorderStyle="Outset" BackColor="White" Height="30px"
Width="97px">Street</asp:label><asp:label id="LabelMFName" style="Z-INDEX: 117; LEFT: 16px;
POSITION: absolute; TOP: 480px" runat="server" ForeColor="Red" Font-Names="Times New Roman"
Font-Bold="True" BorderColor="Red" BorderStyle="Outset" BackColor="White" Height="30px"
Width="97px">F Name</asp:label><asp:label id="LabelMLName" style="Z-INDEX: 116; LEFT: 16px;
POSITION: absolute; TOP: 448px" runat="server" ForeColor="Red" Font-Names="Times New Roman"
Font-Bold="True" BorderColor="Red" BorderStyle="Outset" BackColor="White" Height="30px"
Width="97px">L Name</asp:label><asp:label id="LabelMState" style="Z-INDEX: 115; LEFT: 320px;
POSITION: absolute; TOP: 448px" runat="server" ForeColor="Red" Font-Names="Times New Roman"
Font-Bold="True" BorderColor="Red" BorderStyle="Outset" BackColor="White" Height="30"
Width="97">State</asp:label><asp:label id="LabelMZip" style="Z-INDEX: 114; LEFT: 320px;
POSITION: absolute; TOP: 480px" runat="server" ForeColor="Red" Font-Names="Times New Roman"
Font-Bold="True" BorderColor="Red" BorderStyle="Outset" BackColor="White" Height="30px"
Width="97px">Zip</asp:label><asp:label id="LabelMPhone" style="Z-INDEX: 113; LEFT: 320px;
POSITION: absolute; TOP: 512px" runat="server" ForeColor="Red" Font-Names="Times New Roman"
Font-Bold="True" BorderColor="Red" BorderStyle="Outset" BackColor="White" Height="30px"
Width="97px">Telephone</asp:label><asp:label id="LabelMEmail" style="Z-INDEX: 112; LEFT: 320px;
POSITION: absolute; TOP: 544px" runat="server" ForeColor="Red" Font-Names="Times New Roman"
Font-Bold="True" BorderColor="Red" BorderStyle="Outset" BackColor="White" Height="30px"
Width="97px">Email</asp:label><asp:textbox id="TextBoxMState" style="Z-INDEX: 111; LEFT: 424px;
POSITION: absolute; TOP: 448px" tabIndex="50" runat="server" BorderColor="Red"
BorderStyle="Outset" BackColor="White" Height="30px" Width="180px"></asp:textbox><asp:textbox
id="TextBoxMEmail" style="Z-INDEX: 110; LEFT: 424px; POSITION: absolute; TOP: 544px"
tabIndex="80" runat="server" BorderColor="Red" BorderStyle="Outset" BackColor="White"
Height="30px" Width="180px"></asp:textbox><asp:textbox id="TextBoxMLName" style="Z-INDEX:
109; LEFT: 120px; POSITION: absolute; TOP: 448px" tabIndex="10" runat="server" BorderColor="Red"
BorderStyle="Outset" BackColor="White" Height="30px" Width="180px"></asp:textbox><asp:textbox
id="TextBoxMCity" style="Z-INDEX: 108; LEFT: 120px; POSITION: absolute; TOP: 544px"
tabIndex="40" runat="server" BorderColor="Red" BorderStyle="Outset" BackColor="White"

```

```

Height="30px" Width="180px"></asp:textbox><asp:textbox id="TextBoxMStreet" style="Z-INDEX: 107;
LEFT: 120px; POSITION: absolute; TOP: 512px" tabIndex="30" runat="server" BorderColor="Red"
BorderStyle="Outset" BackColor="White" Height="30px" Width="180px"></asp:textbox><asp:textbox
id="TextBoxMPhone" style="Z-INDEX: 106; LEFT: 424px; POSITION: absolute; TOP: 512px"
tabIndex="70" runat="server" BorderColor="Red" BorderStyle="Outset" BackColor="White"
Height="30px" Width="180px"></asp:textbox><asp:textbox id="TextBoxMFName" style="Z-INDEX:
105; LEFT: 120px; POSITION: absolute; TOP: 480px" tabIndex="20" runat="server" BorderColor="Red"
BorderStyle="Outset" BackColor="White" Height="30" Width="180px"></asp:textbox><asp:label
id="LabelMember" style="Z-INDEX: 101; LEFT: 120px; POSITION: absolute; TOP: 16px"
runat="server" Font-Underline="True" Font-Size="Large" ForeColor="Red" Font-Names="Times New
Roman" Font-Bold="True" BorderColor="Red" BorderStyle="Outset" BackColor="White" Height="24px"
Width="496px">UC Robotics Team Member Information</asp:label><asp:dropdownlist
id="DDMemberID" style="Z-INDEX: 102; LEFT: 120px; POSITION: absolute; TOP: 416px"
runat="server" ForeColor="Red" Font-Names="Times New Roman" Font-Bold="True"
BackColor="White" Height="30px" Width="180px" AutoPostBack="True"
OnSelectedIndexChanged="DDMember_IDSelect"></asp:dropdownlist><asp:label id="LabelMID"
style="Z-INDEX: 103; LEFT: 16px; POSITION: absolute; TOP: 411px" runat="server" ForeColor="Red"
Font-Names="Times New Roman" Font-Bold="True" BorderColor="Red" BorderStyle="Outset"
BackColor="White" Height="30px" Width="97px">MemberID</asp:label><asp:textbox
id="TextBoxMZip" style="Z-INDEX: 104; LEFT: 424px; POSITION: absolute; TOP: 480px"
tabIndex="60" runat="server" BorderColor="Red" BorderStyle="Outset" BackColor="White"
Height="30px" Width="180px"></asp:textbox>
<div dataFormatAs="html" style="Z-INDEX: 124; BORDER-LEFT-COLOR:
#ff0033; LEFT: 8px; BORDER-BOTTOM-COLOR: #ff0033; OVERFLOW: auto; WIDTH: 792px;
COLOR: red; BORDER-TOP-STYLE: outset; BORDER-TOP-COLOR: #ff0033; BORDER-RIGHT-
STYLE: outset; BORDER-LEFT-STYLE: outset; POSITION: absolute; TOP: 96px; HEIGHT: 298px;
BACKGROUND-COLOR: transparent; TEXT-DECORATION: underline; BORDER-RIGHT-COLOR:
#ff0033; BORDER-BOTTOM-STYLE: outset"><asp:datagrid id="DGMember" runat="server" Font-
Names="Times New Roman" BorderColor="Red" BorderStyle="Outset" BackColor="White"
Height="292px" Width="496px" PageSize="5" BorderWidth="0mm" HorizontalAlign="Center">
<SelectedItemStyle Wrap="False"></SelectedItemStyle>
<EditItemStyle Wrap="False"></EditItemStyle>
<AlternatingItemStyle Wrap="False"
HorizontalAlign="Center" VerticalAlign="Middle"></AlternatingItemStyle>
<ItemStyle Font-Names="Times New Roman" Wrap="False"
HorizontalAlign="Center" ForeColor="Red" BorderStyle="Outset" VerticalAlign="Middle"></ItemStyle>
<HeaderStyle Font-Size="Larger" Font-Underline="True"
Font-Bold="True" Wrap="False" HorizontalAlign="Center" ForeColor="Red" BorderStyle="Outset"
VerticalAlign="Middle" BackColor="Black"></HeaderStyle>
<PagerStyle VerticalAlign="Middle" BorderColor="Red"
HorizontalAlign="Center" Wrap="False"></PagerStyle>
</asp:datagrid></div>
<asp:textbox id="TextBoxTemp" style="Z-INDEX: 126; LEFT: 320px;
POSITION: absolute; TOP: 416px" runat="server" Height="24px" Width="94px"
Visible="False"></asp:textbox><asp:textbox id="TextBoxTemp2" style="Z-INDEX: 127; LEFT: 432px
POSITION: absolute; TOP: 416px" runat="server" Height="24px" Width="104px"
Visible="False"></asp:textbox></FORM>
</body>
</HTML>

```

Sponsor Form

```

<% @ Page Language="vb" %>
<% @ Import Namespace="System.Data"%>
<% @ Import Namespace="System.Data.OleDb"%>
<!DOCTYPE HTML PUBLIC "-//W3C//DTD HTML 4.0 Transitional//EN">
<HTML>
<HEAD>
<title>Member</title>

```

```

        <script language="vb" runat="server">
        Sub AddPL()
        Dim ObjDataset as New Dataset()
        Dim StrConnection as string = "provider=Microsoft.Jet.OLEDB.4.0;Data Source =
f:\wwwroot\sujan\thesis1\thesis1.mdb"
        Dim StrSQL as String = "Select * from Sponsor_Information"
        Dim ObjConnection as New OledbConnection(StrConnection)
        Dim ObjAdapter as New OledbDataAdapter(StrSQL, ObjConnection)
        ObjAdapter.Fill(ObjDataset,"Sponsor_Information")
        Dim ObjView as New DataView(ObjDataset.Tables("Sponsor_Information"))

        Dim ObjCommand as New OledbCommand(StrSQL,ObjConnection)
        ObjConnection.open()
        DGMember.DataSource = ObjView
        DGMember.DataBind()
        DDMemberID.DataSource = ObjView
        DDMemberID.DataMember = "Sponsor_ID"
        DDMemberID.DataValueField = "Sponsor_ID"
        DDMemberID.DataBind()
        Dim ObjRow as datarow = ObjDataset.Tables("Sponsor_Information").Rows(0)
        TextBoxMLName.Text=ObjRow.Item("Last_Name")
        TextBoxMFName.Text=ObjRow.Item("First_Name")
        TextBoxMStreet.Text=ObjRow.Item("Street_Address")
        TextBoxMCity.Text=ObjRow.Item("City")
        TextBoxMState.Text=ObjRow.Item("State")
        TextBoxMZip.Text=ObjRow.Item("Zip")
        TextBoxMPhone.Text=ObjRow.Item("Telephone")
        TextBoxMEmail.Text=ObjRow.Item("E_Mail")
        TextBoxMAmount.Text=ObjRow.Item("Amount")
        TextBoxMYear.Text=ObjRow.Item("Year")
        TextBoxTemp2.Text=ObjRow.Item("Sponsor_ID")
        End Sub

        Sub Page_Load()
        If Session("Log")="A" OR Session("Log")= "U" then
        Dim ObjDataset as New Dataset()
        Dim StrConnection as string = "provider=Microsoft.Jet.OLEDB.4.0;Data Source =
f:\wwwroot\sujan\thesis1\thesis1.mdb"
        Dim StrSQL as String = "Select * from Sponsor_Information"
        Dim ObjConnection as New OledbConnection(StrConnection)
        Dim ObjAdapter as New OledbDataAdapter(StrSQL, ObjConnection)
        ObjAdapter.Fill(ObjDataset,"Sponsor_Information")
        Dim ObjView as New DataView(ObjDataset.Tables("Sponsor_Information"))

        Dim ObjCommand as New OledbCommand(StrSQL,ObjConnection)
        ObjConnection.open()
        if not is postback then
        DGMember.DataSource = ObjView
        DGMember.DataBind()
        DDMemberID.DataSource = ObjView
        DDMemberID.DataMember = "Sponsor_ID"
        DDMemberID.DataValueField = "Sponsor_ID"
        DDMemberID.DataBind()
        Dim ObjRow as datarow = ObjDataset.Tables("Sponsor_Information").Rows(0)
        TextBoxMLName.Text=ObjRow.Item("Last_Name")
        TextBoxMFName.Text=ObjRow.Item("First_Name")
        TextBoxMStreet.Text=ObjRow.Item("Street_Address")
        TextBoxMCity.Text=ObjRow.Item("City")

```



```

TextBoxMState.Text=ObjRow.Item("State")
TextBoxMZip.Text=ObjRow.Item("Zip")
TextBoxMPhone.Text=ObjRow.Item("Telephone")
TextBoxMEmail.Text=ObjRow.Item("E_Mail")
TextBoxMAmount.Text=ObjRow.Item("Amount")
TextBoxMYear.Text=ObjRow.Item("Year")
TextBoxTemp2.Text=ObjRow.Item("Sponsor_ID")
ButtonMAdd.Enabled=False
end if
ObjConnection.Close()
If Session("Log")<>"A" then
DDMemberID.Visible=False
TextBoxMFName.Visible=False
TextBoxMLName.Visible=False
TextBoxMStreet.Visible=False
TextBoxMCity.Visible=False
TextBoxMState.Visible=False
TextBoxMZip.Visible=False
TextBoxMPhone.Visible=False
TextBoxMEmail.Visible=False
textBoxMAmount.Visible=False
TextBoxMYear.Visible=False
LabelMID.Visible=False
LabelMFName.Visible=False
LabelMLName.Visible=False
LabelMStreet.Visible=False
LabelMCity.Visible=False
LabelMState.Visible=False
LabelMZip.Visible=False
LabelMPhone.Visible=False
LabelMEmail.Visible=False
LabelMAmount.Visible=False
LabelMYear.Visible=False
ButtonMAdd.Visible=False
ButtonMModify.Visible=False
ButtonMDelete.Visible=False
ButtonMClear.Visible=False
End If
Else
response.redirect("http://10.85.2.251/sujan/thesis1/FrmLogin.aspx")
End IF
End Sub

Sub DDMember_IDSelect( S1 as Object, E1 as EventArgs)
Dim ObjDataset as New Dataset()
Dim StrConnection as string = "provider=Microsoft.Jet.OLEDB.4.0;Data Source =
f:\wwwroot\sujan\thesis1\thesis1.mdb"
Dim ObjConnection as New OleDbConnection(StrConnection)
Dim StrSQL as String = "Select * from Sponsor_Information where " & "Sponsor_ID = " &
DDMemberID.SelectedItem.value & " ' "
Dim ObjAdapter as New OleDbDataAdapter(StrSQL, ObjConnection)
ObjAdapter.Fill(ObjDataset,"Sponsor_Information")
Dim ObjRow as datarow = ObjDataset.Tables("Sponsor_Information").Rows(0)
TextBoxMLName.Text=ObjRow.Item("Last_Name")
TextBoxMFName.Text=ObjRow.Item("First_Name")
TextBoxMStreet.Text=ObjRow.Item("Street_Address")
TextBoxMCity.Text=ObjRow.Item("City")
TextBoxMState.Text=ObjRow.Item("State")

```

```

    TextBoxMZip.Text=ObjRow.Item("Zip")
    TextBoxMPhone.Text=ObjRow.Item("Telephone")
    TextBoxMEmail.Text=ObjRow.Item("E_Mail")
    TextBoxMAmount.Text=ObjRow.Item("Amount")
    TextBoxMYear.Text=ObjRow.Item("Year")
    TextBoxTemp2.text=ObjRow.Item("Sponsor_ID")
    ObjConnection.Close()
    ButtonMAdd.Enabled=False
End Sub

Sub MAdd( S as Object, E As EventArgs)
    Dim ObjDataset as New Dataset()
    Dim StrConnection as string = "provider=Microsoft.Jet.OLEDB.4.0;Data Source =
f:\wwwroot\sujan\thesis1\thesis1.mdb"
    Dim ObjConnection as New OleDbConnection(StrConnection)
    Dim StrSQL as String = "Select Sponsor_ID from Sponsor_Information"
    Dim ObjAdapter as New OleDbDataAdapter(StrSQL, ObjConnection)
    ObjConnection.Open()
    ObjAdapter.Fill(ObjDataset,"Sponsor_ID")
    Dim ObjRow as DataRow =
ObjDataset.Tables("Sponsor_ID").Rows(ObjDataset.Tables("Sponsor_ID").Rows.Count - 1)
    Dim TempID as String = ObjRow.Item("Sponsor_ID")
    Dim TempID1 as string = Right(TempID, 4)
    Dim ITempID as Integer = Cint(TempID1)+1
    Dim TempID2 as String
    If ITempID < 10 Then
    TempID2 ="S000" + cstr(ITempID)
    Else If ITempID < 100 Then
    TempID2 ="S00" + cstr(ITempID)
    Else If ITempID < 1000 Then
    TempID2 ="S0" + cstr(ITempID)
    Else
    TempID2 ="S" + cstr(ITempID)
    End IF
    TextBoxTemp.Text = TempID2
    If TextBoxMLName.Text="" then
    TextBoxMLName.Text="-"
    end if
    If TextBoxMFName.Text="" then
    TextBoxMFName.Text="-"
    end if
    If TextBoxMStreet.Text="" then
    TextBoxMStreet.Text="-"
    end if
    If TextBoxMCity.Text="" then
    TextBoxMCity.Text="-"
    end if
    If TextBoxMState.Text="" then
    TextBoxMState.Text="-"
    end if
    If TextBoxMZip.Text="" then
    TextBoxMZip.Text="-"
    end if
    If TextBoxMPhone.Text="" then
    TextBoxMPhone.Text="-"
    end if
    If TextBoxMEMail.Text="" then
    TextBoxMEMail.Text="-"

```

```

end if
If TextBoxMAmount.Text="" then
TextBoxMAmount.Text="-"
end if
If TextBoxMYear.Text="" then
TextBoxMYear.Text="-"
end if
StrSql = " Insert into `Sponsor_Information`
(`Sponsor_ID`,`Last_Name`,`First_Name`,`Street_Address`,`City`,`State`,`Zip`,`Telephone`,`E-Mail`,`Amount`,`Year`)" & _
" Values (" & _
"" & TextBoxTemp.Text & "," & _
"" & TextBoxMLName.Text & "," & _
"" & TextBoxMFName.Text & "," & _
"" & TextBoxMStreet.Text & "," & _
"" & TextBoxMCity.Text & "," & _
"" & TextBoxMState.Text & "," & _
"" & TextBoxMZip.Text & "," & _
"" & TextBoxMPhone.Text & "," & _
"" & TextBoxMEMail.Text & "," & _
"" & TextBoxMAmount.Text & "," & _
"" & TextBoxMYear.Text & ")"

Dim ObjCommand as New OleDbCommand(StrSql,ObjConnection)
ObjCommand.ExecuteNonQuery()
ObjConnection.Close()
Call AddPL()
End Sub

Sub MClear(S as Object, E as EventArgs)
TextBoxMLName.Text=""
TextBoxMFName.Text=""
TextBoxMStreet.Text=""
TextBoxMCity.Text=""
TextBoxMState.Text=""
TextBoxMZip.Text=""
TextBoxMPhone.Text=""
TextBoxMEmail.Text=""
TextBoxMAmount.Text=""
TextBoxMYear.Text=""
ButtonMAdd.Enabled=True
End Sub

Sub MModify(S As Object, E as EventArgs)
Dim StrConnection as string = "provider=Microsoft.Jet.OLEDB.4.0;Data Source =
f:\wwwroot\sujan\thesis1\thesis1.mdb"
Dim ObjConnection as New OleDbConnection(StrConnection)
ObjConnection.Open()
Dim StrSql as String
StrSql = " Update `Sponsor_Information` Set " & _
"" & TextBoxMLName.Text & "," & _
"" & TextBoxMFName.Text & "," & _
"" & TextBoxMStreet.Text & "," & _
"" & TextBoxMCity.Text & "," & _
"" & TextBoxMState.Text & "," & _
"" & TextBoxMZip.Text & "," & _
"" & TextBoxMPhone.Text & "," & _
"" & TextBoxMEmail.Text & "," & _

```

```

        ``Amount`= "" & TextBoxMAmount.Text & "," & _
        ``Year`= "" & TextBoxMYear.Text & "" & _
        " Where (`Sponsor_ID`= "" & TextBoxTemp2.Text & "")"
        Dim ObjCommand as New OleDbCommand(StrSql,ObjConnection)
    ObjCommand.ExecuteNonQuery()
    ObjConnection.Close()
    Call AddPL()
End Sub

Sub MDelete(S As Object, E as EventArgs)
    Dim StrConnection as string = "provider=Microsoft.Jet.OLEDB.4.0;Data Source =
f:\wwwroot\sujan\thesis1\thesis1.mdb"
    Dim ObjConnection as New OleDbConnection(StrConnection)
    ObjConnection.Open()
    Dim StrSql as String
    StrSql = "Delete from `Sponsor_Information` where (`Sponsor_ID`= "" & TextBoxTemp2.Text &
""))"
    Dim ObjCommand as New OleDbCommand(StrSql,ObjConnection)
    ObjCommand.ExecuteNonQuery()
    ObjConnection.Close()
    Call AddPL()
End Sub

Sub MLogout(S As Object, E As EventArgs)
    Session.abandon()
    response.redirect("http://10.85.2.251/sujan/thesis1/FrmLogin.aspx")
End Sub

```

```

</script>
<meta content="Microsoft Visual Studio.NET 7.0" name="GENERATOR">
<meta content="Visual Basic 7.0" name="CODE_LANGUAGE">
<meta content="JavaScript" name="vs_defaultClientScript">
<meta content="http://schemas.microsoft.com/intellisense/ie5"
name="vs_targetSchema">
</HEAD>
<body bgColor="#000000" MS_POSITIONING="GridLayout">
    <FORM id="Form1" method="post" runat="server">
        <asp:button id="ButtonLogout" style="Z-INDEX: 123; LEFT: 592px;
POSITION: absolute; TOP: 56px" runat="server" OnClick="MLogout" Width="56px" Height="24px"
BackColor="White" BorderStyle="Outset" BorderColor="Red" Font-Bold="True" Font-Names="Times
New Roman" ForeColor="Red" Font-Size="Smaller" Font-Underline="True"
Text="Logout"></asp:button>
        <asp:textbox id="TextboxMYear" style="Z-INDEX: 131; LEFT: 424px;
POSITION: absolute; TOP: 576px" tabIndex="80" runat="server" BorderColor="Red"
BorderStyle="Outset" BackColor="White" Height="30px" Width="180px"></asp:textbox>
        <asp:textbox id="TextBoxMAmount" style="Z-INDEX: 130; LEFT: 424px;
POSITION: absolute; TOP: 544px" tabIndex="80" runat="server" BorderColor="Red"
BorderStyle="Outset" BackColor="White" Height="30px" Width="180px"></asp:textbox>
        <asp:label id="LabelMYear" style="Z-INDEX: 129; LEFT: 320px; POSITION:
absolute; TOP: 576px" runat="server" ForeColor="Red" Font-Names="Times New Roman" Font-
Bold="True" BorderColor="Red" BorderStyle="Outset" BackColor="White" Height="30px"
Width="97px">Year</asp:label>
        <asp:label id="LabelMAmount" style="Z-INDEX: 128; LEFT: 320px;
POSITION: absolute; TOP: 544px" runat="server" ForeColor="Red" Font-Names="Times New Roman"
Font-Bold="True" BorderColor="Red" BorderStyle="Outset" BackColor="White" Height="30px"

```

Width="97px">Amount</asp:label><asp:button id="ButtonMAdd" style="Z-INDEX: 125; LEFT: 648px; POSITION: absolute; TOP: 424px" onclick="MAdd" tabIndex="90" runat="server" Width="100px" Height="30px" BackColor="White" BorderStyle="Outset" BorderColor="Red" Font-Bold="True" FontNames="Times New Roman" ForeColor="Red" Font-Size="Larger" Text="Add"></asp:button><asp:button id="ButtonMClear" style="Z-INDEX: 122; LEFT: 648px; POSITION: absolute; TOP: 544px" onclick="MClear" tabIndex="120" runat="server" Width="100px" Height="30px" BackColor="White" BorderStyle="Outset" BorderColor="Red" Font-Bold="True" FontNames="Times New Roman" ForeColor="Red" Font-Size="Larger" Text="Clear"></asp:button><asp:button id="ButtonMDelete" style="Z-INDEX: 121; LEFT: 648px; POSITION: absolute; TOP: 504px" tabIndex="110" runat="server" OnClick="MDelete" Width="100px" Height="30px" BackColor="White" BorderStyle="Outset" BorderColor="Red" Font-Bold="True" FontNames="Times New Roman" ForeColor="Red" Font-Size="Larger" Text="Delete"></asp:button><asp:button id="ButtonMModify" style="Z-INDEX: 120; LEFT: 648px; POSITION: absolute; TOP: 464px" tabIndex="100" runat="server" OnClick="MModify" Width="100px" Height="30px" BackColor="White" BorderStyle="Outset" BorderColor="Red" Font-Bold="True" FontNames="Times New Roman" ForeColor="Red" Font-Size="Larger" Text="Modify"></asp:button><asp:label id="LabelMCity" style="Z-INDEX: 119; LEFT: 16px; POSITION: absolute; TOP: 544px" runat="server" Width="97px" Height="30px" BackColor="White" BorderStyle="Outset" BorderColor="Red" Font-Bold="True" FontNames="Times New Roman" ForeColor="Red">City</asp:label><asp:label id="LabelMStreet" style="Z-INDEX: 118; LEFT: 16px; POSITION: absolute; TOP: 513px" runat="server" Width="97px" Height="30px" BackColor="White" BorderStyle="Outset" BorderColor="Red" Font-Bold="True" FontNames="Times New Roman" ForeColor="Red">Street</asp:label><asp:label id="LabelMFName" style="Z-INDEX: 117; LEFT: 16px; POSITION: absolute; TOP: 481px" runat="server" Width="97px" Height="30px" BackColor="White" BorderStyle="Outset" BorderColor="Red" Font-Bold="True" FontNames="Times New Roman" ForeColor="Red">F Name</asp:label><asp:label id="LabelMLName" style="Z-INDEX: 116; LEFT: 16px; POSITION: absolute; TOP: 449px" runat="server" Width="97px" Height="30px" BackColor="White" BorderStyle="Outset" BorderColor="Red" Font-Bold="True" FontNames="Times New Roman" ForeColor="Red">L Name</asp:label><asp:label id="LabelMState" style="Z-INDEX: 115; LEFT: 16px; POSITION: absolute; TOP: 576px" runat="server" Width="97" Height="30" BackColor="White" BorderStyle="Outset" BorderColor="Red" Font-Bold="True" FontNames="Times New Roman" ForeColor="Red">State</asp:label><asp:label id="LabelMZip" style="Z-INDEX: 114; LEFT: 320px; POSITION: absolute; TOP: 449px" runat="server" Width="97px" Height="30px" BackColor="White" BorderStyle="Outset" BorderColor="Red" Font-Bold="True" FontNames="Times New Roman" ForeColor="Red">Zip</asp:label><asp:label id="LabelMPhone" style="Z-INDEX: 113; LEFT: 320px; POSITION: absolute; TOP: 481px" runat="server" Width="97px" Height="30px" BackColor="White" BorderStyle="Outset" BorderColor="Red" Font-Bold="True" FontNames="Times New Roman" ForeColor="Red">Telephone</asp:label><asp:label id="LabelMEmail" style="Z-INDEX: 112; LEFT: 320px; POSITION: absolute; TOP: 513px" runat="server" Width="97px" Height="30px" BackColor="White" BorderStyle="Outset" BorderColor="Red" Font-Bold="True" FontNames="Times New Roman" ForeColor="Red">Email</asp:label><asp:textbox id="TextBoxMState" style="Z-INDEX: 111; LEFT: 120px; POSITION: absolute; TOP: 575px" tabIndex="50" runat="server" Width="180px" Height="30px" BackColor="White" BorderStyle="Outset" BorderColor="Red"></asp:textbox><asp:textbox id="TextBoxMEmail" style="Z-INDEX: 110; LEFT: 424px; POSITION: absolute; TOP: 512px" tabIndex="80" runat="server" Width="180px" Height="30px" BackColor="White" BorderStyle="Outset" BorderColor="Red"></asp:textbox><asp:textbox id="TextBoxMLName" style="Z-INDEX: 108; LEFT: 120px; POSITION: absolute; TOP: 448px" tabIndex="10" runat="server" Width="180px" Height="30px" BackColor="White" BorderStyle="Outset" BorderColor="Red"></asp:textbox><asp:textbox id="TextBoxMCity" style="Z-INDEX: 107; LEFT: 120px; POSITION: absolute; TOP: 543px" tabIndex="40" runat="server" Width="180px" Height="30px" BackColor="White" BorderStyle="Outset" BorderColor="Red"></asp:textbox><asp:textbox id="TextBoxMStreet" style="Z-INDEX: 106; LEFT: 120px; POSITION: absolute; TOP: 512px" tabIndex="30" runat="server" Width="180px" Height="30px" BackColor="White" BorderStyle="Outset" BorderColor="Red"></asp:textbox><asp:textbox id="TextBoxMPhone" style="Z-INDEX: 105; LEFT: 424px; POSITION: absolute; TOP: 480px" tabIndex="70" runat="server" Width="180px" Height="30px" BackColor="White" BorderStyle="Outset" BorderColor="Red"></asp:textbox><asp:textbox id="TextBoxMFName" style="Z-INDEX: 104; LEFT: 120px; POSITION: absolute; TOP: 480px" tabIndex="20" runat="server" Width="180px" Height="30" BackColor="White" BorderStyle="Outset"

```

BorderColor="Red"></asp:textbox><asp:label id="LabelMember" style="Z-INDEX: 100; LEFT: 48px;
POSITION: absolute; TOP: 24px" runat="server" Width="432px" Height="24px" BackColor="White"
BorderStyle="Outset" BorderColor="Red" Font-Bold="True" Font-Names="Times New Roman"
ForeColor="Red" Font-Size="Large" Font-Underline="True">UC Robotics Team Sponsor
Information</asp:label><asp:dropdownlist id="DDMemberID" style="Z-INDEX: 101; LEFT: 120px;
POSITION: absolute; TOP: 416px" runat="server" Width="180px" Height="30px" BackColor="White"
Font-Bold="True" Font-Names="Times New Roman" ForeColor="Red"
OnSelectedIndexChanged="DDMember_IDSelect" AutoPostBack="True"></asp:dropdownlist><asp:label
id="LabelMID" style="Z-INDEX: 102; LEFT: 16px; POSITION: absolute; TOP: 411px" runat="server"
Width="97px" Height="30px" BackColor="White" BorderStyle="Outset" BorderColor="Red" Font-
Bold="True" Font-Names="Times New Roman" ForeColor="Red">SponsorID</asp:label><asp:textbox
id="TextBoxMZip" style="Z-INDEX: 103; LEFT: 424px; POSITION: absolute; TOP: 448px"
TabIndex="60" runat="server" Width="180px" Height="30px" BackColor="White" BorderStyle="Outset"
BorderColor="Red"></asp:textbox>
<div dataFormatAs="html" style="Z-INDEX: 124; BORDER-LEFT-COLOR:
#ff0033; LEFT: 8px; BORDER-BOTTOM-COLOR: #ff0033; OVERFLOW: auto; WIDTH: 810px;
COLOR: red; BORDER-TOP-STYLE: outset; BORDER-TOP-COLOR: #ff0033; BORDER-RIGHT-
STYLE: outset; BORDER-LEFT-STYLE: outset; POSITION: absolute; TOP: 96px; HEIGHT: 298px;
BACKGROUND-COLOR: transparent; TEXT-DECORATION: overline; BORDER-RIGHT-COLOR:
#ff0033; BORDER-BOTTOM-STYLE: outset"><asp:datagrid id="DGMember" runat="server"
Width="496px" Height="292px" HorizontalAlign="Center" BackColor="White" BorderStyle="Outset"
BorderColor="Red" Font-Names="Times New Roman" BorderWidth="0mm" PageSize="5">
<SelectedItemStyle Wrap="False"></SelectedItemStyle>
<EditItemStyle Wrap="False"></EditItemStyle>
<AlternatingItemStyle Wrap="False"
HorizontalAlign="Center" VerticalAlign="Middle"></AlternatingItemStyle>
<ItemStyle Font-Names="Times New Roman" Wrap="False"
HorizontalAlign="Center" ForeColor="Red" BorderStyle="Outset" VerticalAlign="Middle"></ItemStyle>
<HeaderStyle Font-Size="Larger" Font-Underline="True"
Font-Bold="True" Wrap="False" HorizontalAlign="Center" ForeColor="Red" BorderStyle="Outset"
VerticalAlign="Middle" BackColor="Black"></HeaderStyle>
<PagerStyle VerticalAlign="Middle" BorderColor="Red"
HorizontalAlign="Center" Wrap="False"></PagerStyle>
</asp:datagrid></div>
<asp:textbox id="TextBoxTemp" style="Z-INDEX: 126; LEFT: 320px;
POSITION: absolute; TOP: 416px" runat="server" Width="94px" Height="24px"
Visible="False"></asp:textbox>
<asp:TextBox id="TextBoxTemp2" style="Z-INDEX: 127; LEFT: 432px;
POSITION: absolute; TOP: 416px" runat="server" Width="104px" Height="24px"
Visible="False"></asp:TextBox></FORM>
</body>
</HTML>

```

Components Form

```

<% @ Page Language="vb" %>
<% @ Import Namespace="System.Data" %>
<% @ Import Namespace="System.Data.OleDb" %>
<!DOCTYPE HTML PUBLIC "-//W3C//DTD HTML 4.0 Transitional//EN">
<HTML>
<HEAD>
<title>Member</title>
<script language="vb" runat="server">
Sub AddPL()
Dim ObjDataset as New Dataset()
Dim StrConnection as string = "provider=Microsoft.Jet.OLEDB.4.0;Data Source =
f:\wwwroot\sujan\thesis1\thesis1.mdb"
Dim StrSQL as String = "Select * from Components"
Dim ObjConnection as New OleDbConnection(StrConnection)

```

```

Dim ObjAdapter as New OleDbDataAdapter(StrSQL, ObjConnection)
ObjAdapter.Fill(ObjDataset,"Components")
Dim ObjView as New DataView(ObjDataset.Tables("Components"))

'Dim ObjCommand as New OleDbCommand(StrSQL,ObjConnection)
ObjConnection.open()
DGMember.DataSource = ObjView
DGMember.DataBind()
DDMemberID.DataSource = ObjView
DDMemberID.DataMember = "Part_ID"
DDMemberID.DataValueField = "Part_ID"
DDmemberID.DataBind()
Dim ObjRow as datarow = ObjDataset.Tables("Components").Rows(0)
TextBoxMLName.Text=ObjRow.Item("Part_Name")
TextBoxMFName.Text=ObjRow.Item("Vendor")
TextBoxMStreet.Text=ObjRow.Item("Cost")
TextBoxMCity.Text=ObjRow.Item("Quantity")
TextBoxMState.Text=ObjRow.Item("Uses")
TextBoxMZip.Text=ObjRow.Item("Subsystems")
TextBoxTemp2.Text=ObjRow.Item("Part_ID")
End Sub

Sub Page_Load()
If Session("Log")="A" OR Session("Log")="U" then

Dim ObjDataset as New Dataset()
Dim StrConnection as string = "provider=Microsoft.Jet.OLEDB.4.0;Data Source =
f:\wwwroot\sujan\thesis1\thesis1.mdb"
Dim StrSQL as String = "Select * from Components"
Dim ObjConnection as New OleDbConnection(StrConnection)
Dim ObjAdapter as New OleDbDataAdapter(StrSQL, ObjConnection)
ObjAdapter.Fill(ObjDataset,"Components")
Dim ObjView as New DataView(ObjDataset.Tables("Components"))

'Dim ObjCommand as New OleDbCommand(StrSQL,ObjConnection)
ObjConnection.open()
if not ispostback then
DGMember.DataSource = ObjView
DGMember.DataBind()

DDMemberID.DataSource = ObjView
DDMemberID.DataMember = "Part_ID"
DDMemberID.DataValueField = "Part_ID"
DDmemberID.DataBind()
Dim ObjRow as datarow = ObjDataset.Tables("Components").Rows(0)
TextBoxMLName.Text=ObjRow.Item("Part_Name")
TextBoxMFName.Text=ObjRow.Item("Vendor")
TextBoxMStreet.Text=ObjRow.Item("Cost")
TextBoxMCity.Text=ObjRow.Item("Quantity")
TextBoxMState.Text=ObjRow.Item("Uses")
TextBoxMZip.Text=ObjRow.Item("Subsystems")
TextBoxTemp2.Text=ObjRow.Item("Part_ID")
ButtonMAdd.Enabled=False
end if

ObjConnection.Close()
If Session("Log")<>"A" then
DDMemberID.Visible=False

```

```

    TextBoxMFName.Visible=False
    TextBoxMLName.Visible=False
    TextBoxMStreet.Visible=False
    TextBoxMCity.Visible=False
    TextBoxMState.Visible=False
    TextBoxMZip.Visible=False
    LabelMID.Visible=False
    LabelMFName.Visible=False
    LabelMLName.Visible=False
    LabelMStreet.Visible=False
    LabelMCity.Visible=False
    LabelMState.Visible=False
    LabelMZip.Visible=False
    ButtonMAdd.Visible=False
    ButtonMModify.Visible=False
    ButtonMDelete.Visible=False
    ButtonMClear.Visible=False
End If
Else
    response.redirect("http://10.85.2.251/sujan/thesis1/FrmLogin.aspx")
End IF
End Sub

Sub DDMember_IDSelect( S1 as Object, E1 as EventArgs)
    Dim ObjDataset as New Dataset()
    Dim StrConnection as string = "provider=Microsoft.Jet.OLEDB.4.0;Data Source =
f:\wwwroot\sujan\thesis1\thesis1.mdb"
    Dim ObjConnection as New OleDbConnection(StrConnection)
    Dim StrSQL as String = "Select * from Components where " & "Part_ID = " &
DDMemberID.SelectedItem.value & " ' "
    Dim ObjAdapter as New OleDbDataAdapter(StrSQL, ObjConnection)
    ObjAdapter.Fill(ObjDataset,"Components")
    Dim ObjRow as datarow = ObjDataset.Tables("Components").Rows(0)
    TextBoxMLName.Text=ObjRow.Item("Part_Name")
    TextBoxMFName.Text=ObjRow.Item("Vendor")
    TextBoxMStreet.Text=ObjRow.Item("Cost")
    TextBoxMCity.Text=ObjRow.Item("Quantity")
    TextBoxMState.Text=ObjRow.Item("Uses")
    TextBoxMZip.Text=ObjRow.Item("Subsystems")
    TextBoxTemp2.Text=ObjRow.Item("Part_ID")
    ObjConnection.Close()
    ButtonMAdd.Enabled=False
End Sub

Sub MAdd( S as Object, E As EventArgs)
    Dim ObjDataset as New Dataset()
    Dim StrConnection as string = "provider=Microsoft.Jet.OLEDB.4.0;Data Source =
f:\wwwroot\sujan\thesis1\thesis1.mdb"
    Dim ObjConnection as New OleDbConnection(StrConnection)
    Dim StrSQL as String = "Select Part_ID from Components"
    Dim ObjAdapter as New OleDbDataAdapter(StrSQL, ObjConnection)
    ObjConnection.Open()
    ObjAdapter.Fill(ObjDataset,"Part_ID")
    Dim ObjRow as Datarow =
ObjDataset.Tables("Part_ID").Rows(ObjDataset.Tables("Part_ID").Rows.Count - 1)
    Dim TempID as String = ObjRow.Item("Part_ID")
    Dim TempID1 as string = Right(TempID, 4)
    Dim ITempID as Integer = Cint(TempID1)+1

```



```

Dim TempID2 as String
If ITempID < 10 Then
TempID2 ="C000" + cstr(ITempID)
Else If ITempID < 100 Then
TempID2 ="C00" + cstr(ITempID)
Else If ITempID < 1000 Then
TempID2 ="C0" + cstr(ITempID)
Else
TempID2 ="C" + cstr(ITempID)
End IF
TextBoxTemp.Text = TempID2
If TextBoxMLName.Text="" then
TextBoxMLName.Text="-"
end if
If TextBoxMFName.Text="" then
TextBoxMFName.Text="-"
end if
If TextBoxMStreet.Text="" then
TextBoxMStreet.Text="-"
end if
If TextBoxMCity.Text="" then
TextBoxMCity.Text="-"
end if
If TextBoxMState.Text="" then
TextBoxMState.Text="-"
end if
If TextBoxMZip.Text="" then
TextBoxMZip.Text="-"
end if
 strSql = " Insert into `Components`
(`Part_ID`,`Part_Name`,`Vendor`,`Cost`,`Quantity`,`Uses`,`Subsystems`) & _
" Values (" & _
"" & TextBoxTemp.Text & "," & _
"" & TextBoxMLName.Text & "," & _
"" & TextBoxMFName.Text & "," & _
"" & TextBoxMStreet.Text & "," & _
"" & TextBoxMCity.Text & "," & _
"" & TextBoxMState.Text & "," & _
"" & TextBoxMZip.Text & ")"
Dim ObjCommand as New OleDbCommand(StrSql,ObjConnection)
ObjCommand.ExecuteNonQuery()
ObjConnection.Close()
Call AddPL()
End Sub

Sub MClear(S as Object, E as EventArgs)
TextBoxMLName.Text=""
TextBoxMFName.Text=""
TextBoxMStreet.Text=""
TextBoxMCity.Text=""
TextBoxMState.Text=""
TextBoxMZip.Text=""
ButtonMAdd.Enabled=True
End Sub

Sub MModify(S As Object, E as EventArgs)
Dim StrConnection as string = "provider=Microsoft.Jet.OLEDB.4.0;Data Source =
f:\wwwroot\sujan\thesis1\thesis1.mdb"

```

```

Dim ObjConnection as New OleDbConnection(StrConnection)
ObjConnection.Open()
Dim StrSql as String
StrSql = " Update `Components` Set " & _
        ""Part_Name`=" & TextBoxMLName.Text & "," & _
        ""Vendor`=" & TextBoxMFName.Text & "," & _
        ""Cost`=" & TextBoxMStreet.Text & "," & _
        ""Quantity`=" & TextBoxMCity.Text & "," & _
        ""Uses`=" & TextBoxMState.Text & "," & _
        ""Subsystems`=" & TextBoxMZip.Text & "" & _
        " Where (`Part_ID`=" & TextBoxTemp2.Text & "")"
Dim ObjCommand as New OleDbCommand(StrSql,ObjConnection)
ObjCommand.ExecuteNonQuery()
ObjConnection.Close()
Call AddPL()
End Sub

Sub MDelete(S As Object, E as EventArgs)
Dim StrConnection as string = "provider=Microsoft.Jet.OLEDB.4.0;Data Source =
f:\wwwroot\sujan\thesis1\thesis1.mdb"
Dim ObjConnection as New OleDbConnection(StrConnection)
ObjConnection.Open()
Dim StrSql as String
StrSql = "Delete from `Components` where (`Part_ID`=" & TextBoxTemp2.Text & "")"
Dim ObjCommand as New OleDbCommand(StrSql,ObjConnection)
ObjCommand.ExecuteNonQuery()
ObjConnection.Close()
Call AddPL()
End Sub

Sub MLogout(S As Object, E As EventArgs)
Session.abandon()
response.redirect("http://10.85.2.251/sujan/thesis1/FrmLogin.aspx")
End Sub

</script>
<meta content="Microsoft Visual Studio.NET 7.0" name="GENERATOR">
<meta content="Visual Basic 7.0" name="CODE_LANGUAGE">
<meta content="JavaScript" name="vs_defaultClientScript">
<meta content="http://schemas.microsoft.com/intellisense/ie5"
name="vs_targetSchema">
</HEAD>
<body bgColor="#000000" MS_POSITIONING="GridLayout">
<FORM id="Form1" method="post" runat="server">
<asp:button id="ButtonLogout" style="Z-INDEX: 119; LEFT: 648px;
POSITION: absolute; TOP: 64px" onclick="MLogout" runat="server" Text="Logout" Font-
Underline="True" Font-Size="Smaller" ForeColor="Red" Font-Names="Times New Roman" Font-
Bold="True" BorderColor="Red" BorderStyle="Outset" BackColor="White" Height="24px"
Width="56px"></asp:button>
<asp:Image id="Image1" style="Z-INDEX: 124; LEFT: 8px; POSITION:
absolute; TOP: 8px" runat="server" Height="80px" Width="96px"
ImageUrl="title_Links.gif"></asp:Image><asp:button id="ButtonMAdd" style="Z-INDEX: 121; LEFT:
648px; POSITION: absolute; TOP: 424px" onclick="MAdd" tabIndex="90" runat="server" Text="Add"
Font-Size="Larger" ForeColor="Red" Font-Names="Times New Roman" Font-Bold="True"
BorderColor="Red" BorderStyle="Outset" BackColor="White" Height="30px"

```

Width="100px"></asp:button><asp:button id="ButtonMClear" style="Z-INDEX: 118; LEFT: 648px; POSITION: absolute; TOP: 544px" onclick="MClear" tabIndex="120" runat="server" Text="Clear" Font-Size="Larger" ForeColor="Red" Font-Names="Times New Roman" Font-Bold="True" BorderColor="Red" BorderStyle="Outset" BackColor="White" Height="30px"

Width="100px"></asp:button><asp:button id="ButtonMDelete" style="Z-INDEX: 117; LEFT: 648px; POSITION: absolute; TOP: 504px" onclick="MDelete" tabIndex="110" runat="server" Text="Delete" Font-Size="Larger" ForeColor="Red" Font-Names="Times New Roman" Font-Bold="True" BorderColor="Red" BorderStyle="Outset" BackColor="White" Height="30px"

Width="100px"></asp:button><asp:button id="ButtonMModify" style="Z-INDEX: 116; LEFT: 648px; POSITION: absolute; TOP: 464px" onclick="MModify" tabIndex="100" runat="server" Text="Modify" Font-Size="Larger" ForeColor="Red" Font-Names="Times New Roman" Font-Bold="True" BorderColor="Red" BorderStyle="Outset" BackColor="White" Height="30px"

Width="100px"></asp:button><asp:label id="LabelMCity" style="Z-INDEX: 115; LEFT: 320px; POSITION: absolute; TOP: 448px" runat="server" ForeColor="Red" Font-Names="Times New Roman" Font-Bold="True" BorderColor="Red" BorderStyle="Outset" BackColor="White" Height="30px"

Width="97px">Quantity</asp:label><asp:label id="LabelMStreet" style="Z-INDEX: 114; LEFT: 16px; POSITION: absolute; TOP: 513px" runat="server" ForeColor="Red" Font-Names="Times New Roman" Font-Bold="True" BorderColor="Red" BorderStyle="Outset" BackColor="White" Height="30px"

Width="105px">Cost</asp:label><asp:label id="LabelMFName" style="Z-INDEX: 113; LEFT: 16px; POSITION: absolute; TOP: 480px" runat="server" ForeColor="Red" Font-Names="Times New Roman" Font-Bold="True" BorderColor="Red" BorderStyle="Outset" BackColor="White" Height="30"

Width="105">Vendor Name</asp:label><asp:label id="LabelMLName" style="Z-INDEX: 112; LEFT: 16px; POSITION: absolute; TOP: 448px" runat="server" ForeColor="Red" Font-Names="Times New Roman" Font-Bold="True" BorderColor="Red" BorderStyle="Outset" BackColor="White" Height="30px"

Width="105px">Part Name</asp:label><asp:label id="LabelMState" style="Z-INDEX: 111; LEFT: 320px; POSITION: absolute; TOP: 480px" runat="server" ForeColor="Red" Font-Names="Times New Roman" Font-Bold="True" BorderColor="Red" BorderStyle="Outset" BackColor="White" Height="30"

Width="97">Uses</asp:label><asp:label id="LabelMZip" style="Z-INDEX: 110; LEFT: 320px; POSITION: absolute; TOP: 513px" runat="server" ForeColor="Red" Font-Names="Times New Roman" Font-Bold="True" BorderColor="Red" BorderStyle="Outset" BackColor="White" Height="30px"

Width="97px">Subsystems</asp:label><asp:textbox id="TextBoxMState" style="Z-INDEX: 109; LEFT: 424px; POSITION: absolute; TOP: 479px" tabIndex="50" runat="server" ForeColor="Black" BorderColor="Red" BorderStyle="Outset" BackColor="White" Height="30px"

Width="180px"></asp:textbox><asp:textbox id="TextBoxMLName" style="Z-INDEX: 108; LEFT: 128px; POSITION: absolute; TOP: 448px" tabIndex="10" runat="server" ForeColor="Black" BorderColor="Red" BorderStyle="Outset" BackColor="White" Height="30px"

Width="180px"></asp:textbox><asp:textbox id="TextBoxMCity" style="Z-INDEX: 107; LEFT: 424px; POSITION: absolute; TOP: 447px" tabIndex="40" runat="server" ForeColor="Black" BorderColor="Red" BorderStyle="Outset" BackColor="White" Height="30px" Width="180px"></asp:textbox><asp:textbox id="TextBoxMStreet" style="Z-INDEX: 106; LEFT: 128px; POSITION: absolute; TOP: 512px" tabIndex="30" runat="server" ForeColor="Black" BorderColor="Red" BorderStyle="Outset" BackColor="White" Height="30px" Width="180px"></asp:textbox><asp:textbox id="TextBoxMFName" style="Z-INDEX: 105; LEFT: 128px; POSITION: absolute; TOP: 480px" tabIndex="20" runat="server" ForeColor="Black" BorderColor="Red" BorderStyle="Outset" BackColor="White" Height="30"

Width="180px"></asp:textbox><asp:label id="LabelMember" style="Z-INDEX: 101; LEFT: 112px; POSITION: absolute; TOP: 16px" runat="server" Font-Underline="True" Font-Size="Large" ForeColor="Red" Font-Names="Times New Roman" Font-Bold="True" BorderColor="Red" BorderStyle="Outset" BackColor="White" Height="24px" Width="528px">UC Robotics Team Robot Component Information</asp:label><asp:dropdownlist id="DDMemberID" style="Z-INDEX: 102; LEFT: 120px; POSITION: absolute; TOP: 416px" runat="server" ForeColor="Red" Font-Names="Times New Roman" Font-Bold="True" BackColor="White" Height="30px" Width="180px" AutoPostBack="True" OnSelectedIndexChanged="DDMember_IDSelect"></asp:dropdownlist><asp:label id="LabelMID" style="Z-INDEX: 103; LEFT: 16px; POSITION: absolute; TOP: 411px" runat="server" ForeColor="Red" Font-Names="Times New Roman" Font-Bold="True" BorderColor="Red" BorderStyle="Outset" BackColor="White" Height="30px" Width="97px">PartID</asp:label><asp:textbox id="TextBoxMZip" style="Z-INDEX: 104; LEFT: 424px; POSITION: absolute; TOP: 512px" tabIndex="60" runat="server" ForeColor="Black" BorderColor="Red" BorderStyle="Outset" BackColor="White" Height="30px" Width="180px"></asp:textbox>

```

        <div dataFormatAs="html" style="Z-INDEX: 120; BORDER-LEFT-COLOR:
#ff0033; LEFT: 8px; BORDER-BOTTOM-COLOR: #ff0033; OVERFLOW: auto; WIDTH: 806px;
COLOR: red; BORDER-TOP-STYLE: outset; BORDER-TOP-COLOR: #ff0033; BORDER-RIGHT-
STYLE: outset; BORDER-LEFT-STYLE: outset; POSITION: absolute; TOP: 96px; HEIGHT: 298px;
BACKGROUND-COLOR: transparent; TEXT-DECORATION: underline; BORDER-RIGHT-COLOR:
#ff0033; BORDER-BOTTOM-STYLE: outset"><asp:datagrid id="DGMember" runat="server" Font-
Names="Times New Roman" BorderColor="Red" BorderStyle="Outset" BackColor="White"
Height="292px" Width="496px" PageSize="5" BorderWidth="0mm" HorizontalAlign="Center">
        <SelectedItemStyle Wrap="False"></SelectedItemStyle>
        <EditItemStyle Wrap="False"></EditItemStyle>
        <AlternatingItemStyle Wrap="False"
HorizontalAlign="Center" VerticalAlign="Middle"></AlternatingItemStyle>
        <ItemStyle Font-Names="Times New Roman" Wrap="False"
HorizontalAlign="Center" ForeColor="Red" BorderStyle="Outset" VerticalAlign="Middle"></ItemStyle>
        <HeaderStyle Font-Size="Larger" Font-Underline="True"
Font-Bold="True" Wrap="False" HorizontalAlign="Center" ForeColor="Red" BorderStyle="Outset"
VerticalAlign="Middle" BackColor="Black"></HeaderStyle>
        <PagerStyle VerticalAlign="Middle" BorderColor="Red"
HorizontalAlign="Center" Wrap="False"></PagerStyle>
    </asp:datagrid></div>
    <asp:textbox id="TextBoxTemp" style="Z-INDEX: 122; LEFT: 320px;
POSITION: absolute; TOP: 416px" runat="server" Height="24px" Width="94px"
Visible="False"></asp:textbox><asp:textbox id="TextBoxTemp2" style="Z-INDEX: 123; LEFT: 432px;
POSITION: absolute; TOP: 416px" runat="server" Height="24px" Width="104px"
Visible="False"></asp:textbox></FORM>
</body>
</HTML>

```

Failure Form

```

<% @Import Namespace="System.Data.OleDb"%>
<% @Import Namespace="System.Data"%>
<% @ Page Language="vb" %>
<!DOCTYPE HTML PUBLIC "-//W3C//DTD HTML 4.0 Transitional//EN">
<HTML>
    <HEAD>
        <title>Member</title>
        <script language="vb" runat="server">
            Sub AddPL()
                Dim ObjDataset as New Dataset()
                Dim StrConnection as string = "provider=Microsoft.Jet.OLEDB.4.0;Data Source =
f:\wwwroot\sujan\thesis1\thesis1.mdb"
                Dim StrSQL as String = "Select * from Failure_Modes"
                Dim ObjConnection as New OleDbConnection(StrConnection)
                Dim ObjAdapter as New OleDbDataAdapter(StrSQL, ObjConnection)
                ObjAdapter.Fill(ObjDataset,"Failure_Modes")
                Dim ObjView as New DataView(ObjDataset.Tables("Failure_Modes"))

                Dim ObjCommand as New OleDbCommand(StrSQL,ObjConnection)
                ObjConnection.open()
                DGMember.DataSource = ObjView
                DGMember.DataBind()
                DDMemberID.DataSource = ObjView
                DDMemberID.DataMember = "Failure_ID"
                DDMemberID.DataValueField = "Failure_ID"
                DDmemberID.DataBind()
                Dim ObjRow as datarow = ObjDataset.Tables("Failure_Modes").Rows(0)
                TextBoxMLName.Text=ObjRow.Item("System")
                TextBoxMFName.Text=ObjRow.Item("Unit")
            End Sub
        </script>
    </HEAD>
    <BODY>
    </BODY>
</HTML>

```

```

    TextBoxMStreet.Text=ObjRow.Item("Failure_Mode")
    TextBoxMCity.Text=ObjRow.Item("Potential_Causes")
    TextBoxMState.Text=ObjRow.Item("Potential_Effects")
    TextBoxMZip.Text=ObjRow.Item("Solutions")
    TextBoxTemp2.Text=ObjRow.Item("Failure_ID")
End Sub

Sub Page_Load()
If Session("Log")="A" OR Session("Log")="U" then

Dim ObjDataset as New Dataset()
Dim StrConnection as string = "provider=Microsoft.Jet.OLEDB.4.0;Data Source =
f:\wwwroot\sujan\thesis1\thesis1.mdb"
Dim StrSQL as String = "Select * from Failure_Modes"
Dim ObjConnection as New OleDbConnection(StrConnection)
Dim ObjAdapter as New OleDbDataAdapter(StrSQL, ObjConnection)
ObjAdapter.Fill(ObjDataset,"Failure_Modes")
Dim ObjView as New DataView(ObjDataset.Tables("Failure_Modes"))

Dim ObjCommand as New OleDbCommand(StrSQL,ObjConnection)
ObjConnection.open()
if not ispostback then
DGMMember.DataSource = ObjView
DGMMember.DataBind()

DDMemberID.DataSource = ObjView
DDMemberID.DataMember = "Failure_ID"
DDMemberID.DataValueField = "Failure_ID"
DDmemberID.DataBind()
Dim ObjRow as datarow = ObjDataset.Tables("Failure_Modes").Rows(0)
TextBoxMLName.Text=ObjRow.Item("System")
TextBoxMFName.Text=ObjRow.Item("Unit")
TextBoxMStreet.Text=ObjRow.Item("Failure_Mode")
TextBoxMCity.Text=ObjRow.Item("Potential_Causes")
TextBoxMState.Text=ObjRow.Item("Potential_Effects")
TextBo xMZip.Text=ObjRow.Item("Solutions")
TextBoxTemp2.Text=ObjRow.Item("Failure_ID")
ButtonMAdd.Enabled=False
end if

ObjConnection.Close()
If Session("Log")<>"A" then
DDMemberID.Visible=False
TextBoxMFName.Visible=False
TextBoxMLName.Visible=False
TextBoxMStreet.Visible=False
TextBoxMCity.Visible=False
TextBoxMState.Visible=False
TextBoxMZip.Visible=False
LabelMID.Visible=False
LabelMFName.Visible=False
LabelMLName.Visible=False
LabelMStreet.Visible=False
LabelMCity.Visible=False
LabelMState.Visible=False
LabelMZip.Visible=False
ButtonMAdd.Visible=False
ButtonMModify.Visible=False

```

```

ButtonMDelete.Visible=False
ButtonMClear.Visible=False
End If
Else
response.redirect("http://10.85.2.251/sujan/thesis1/FrmLogin.aspx")
End IF
End Sub

Sub DDMember_IDSelect( S1 as Object, E1 as EventArgs)
Dim ObjDataset as New Dataset()
Dim StrConnection as string = "provider=Microsoft.Jet.OLEDB.4.0;Data Source =
f:\wwwroot\sujan\thesis1\thesis1.mdb"
Dim ObjConnection as New OleDbConnection(StrConnection)
Dim StrSQL as String = "Select * from Failure_Modes where " & "Failure_ID = " &
DDMemberID.SelectedItem.value & " ' "
Dim ObjAdapter as New OleDbDataAdapter(StrSQL, ObjConnection)
ObjAdapter.Fill(ObjDataset,"Failure_Modes")
Dim ObjRow as datarow = ObjDataset.Tables("Failure_Modes").Rows(0)
TextBoxMLName.Text=ObjRow.Item("System")
TextBoxMFName.Text=ObjRow.Item("Unit")
TextBoxMStreet.Text=ObjRow.Item("Failure_Mode")
TextBoxMCity.Text=ObjRow.Item("Potential_Causes")
TextBoxMState.Text=ObjRow.Item("Potential_Effects")
TextBoxMZip.Text=ObjRow.Item("Solutions")
TextBoxTemp2.Text=ObjRow.Item("Failure_ID")
ObjConnection.Close()
ButtonMAdd.Enabled=False
End Sub

Sub MAdd( S as Object, E As EventArgs)
Dim ObjDataset as New Dataset()
Dim StrConnection as string = "provider=Microsoft.Jet.OLEDB.4.0;Data Source =
f:\wwwroot\sujan\thesis1\thesis1.mdb"
Dim ObjConnection as New OleDbConnection(StrConnection)
Dim StrSQL as String = "Select Failure_ID from Failure_Modes"
Dim ObjAdapter as New OleDbDataAdapter(StrSQL, ObjConnection)
ObjConnection.Open()
ObjAdapter.Fill(ObjDataset,"Failure_ID")
Dim ObjRow as Datarow =
ObjDataset.Tables("Failure_ID").Rows(ObjDataset.Tables("Failure_ID").Rows.Count - 1)
Dim TempID as String = ObjRow.Item("Failure_ID")
Dim TempID1 as string = Right(TempID, 4)
Dim ITempID as Integer = Cint(TempID1)+1
Dim TempID2 as String
If ITempID < 10 Then
TempID2 ="F000" + cstr(ITempID)
Else If ITempID < 100 Then
TempID2 ="F00" + cstr(ITempID)
Else If ITempID < 1000 Then
TempID2 ="F0" + cstr(ITempID)
Else
TempID2 ="F" + cstr(ITempID)
End IF
TextBoxTemp.Text = TempID2
If TextBoxMLName.Text="" then
TextBoxMLName.Text="-"
end if
If TextBoxMFName.Text="" then

```

```

    TextBoxMFName.Text="-"
end if
If TextBoxMStreet.Text="" then
    TextBoxMStreet.Text="-"
end if
If TextBoxMCity.Text="" then
    TextBoxMCity.Text="-"
end if
If TextBoxMState.Text="" then
    TextBoxMState.Text="-"
end if
If TextBoxMZip.Text="" then
    TextBoxMZip.Text="-"
end if
 strSql = " Insert into `Failure_Modes`
(`Failure_ID`,`System`,`Unit`,`Failure_Mode`,`Potential_Causes`,`Potential_Effects`,`Solutions`)" & _
" Values (" & _
"" & TextBoxTemp.Text & "," & _
"" & TextBoxMLName.Text & "," & _
"" & TextBoxMFName.Text & "," & _
"" & TextBoxMStreet.Text & "," & _
"" & TextBoxMCity.Text & "," & _
"" & TextBoxMState.Text & "," & _
"" & TextBoxMZip.Text & ")"
Dim ObjCommand as New OleDbCommand(StrSql,ObjConnection)
ObjCommand.ExecuteNonQuery()
ObjConnection.Close()
Call AddPL()
End Sub

Sub MClear(S as Object, E as EventArgs)
    TextBoxMLName.Text=""
    TextBoxMFName.Text=""
    TextBoxMStreet.Text=""
    TextBoxMCity.Text=""
    TextBoxMState.Text=""
    TextBoxMZip.Text=""
    ButtonMAdd.Enabled=True
End Sub

Sub MModify(S As Object, E as EventArgs)
    Dim StrConnection as string = "provider=Microsoft.Jet.OLEDB.4.0;Data Source =
f:\wwwroot\sujan\thesis1\thesis1.mdb"
    Dim ObjConnection as New OleDbConnection(StrConnection)
    ObjConnection.Open()
    Dim StrSql as String
    StrSql = " Update `Failure_Modes` Set " & _
"" & TextBoxMLName.Text & "," & _
"" & TextBoxMFName.Text & "," & _
"" & TextBoxMStreet.Text & "," & _
"" & TextBoxMCity.Text & "," & _
"" & TextBoxM State.Text & "," & _
"" & TextBoxMZip.Text & "" & _
" Where (`Failure_ID`=" & TextBoxTemp2.Text & ")"
    Dim ObjCommand as New OleDbCommand(StrSql,ObjConnection)
    ObjCommand.ExecuteNonQuery()
    ObjConnection.Close()
    Call AddPL()

```

End Sub

```
Sub MDelete(S As Object, E as EventArgs)
Dim StrConnection as string = "provider=Microsoft.Jet.OLEDB.4.0;Data Source =
f:\wwwroot\sujan\thesis1\thesis1.mdb"
Dim ObjConnection as New OleDbConnection(StrConnection)
ObjConnection.Open()
Dim StrSql as String
StrSql = "Delete from `Failure_Modes` where (`Failure_ID`= "" & TextBoxTemp2.Text & "")"
Dim ObjCommand as New OleDbCommand(StrSql,ObjConnection)
ObjCommand.ExecuteNonQuery()
ObjConnection.Close()
Call AddPL()
End Sub
```

```
Sub MLogout(S As Object, E As EventArgs)
Session.abandon()
response.redirect("http://10.85.2.251/sujan/thesis1/FrmLogin.aspx")
End Sub
```

```
</script>
<meta content="Microsoft Visual Studio.NET 7.0" name="GENERATOR">
<meta content="Visual Basic 7.0" name="CODE_LANGUAGE">
<meta content="JavaScript" name="vs_defaultClientScript">
<meta content="http://schemas.microsoft.com/intellisense/ie5"
name="vs_targetSchema">
</HEAD>
<body bgColor="#000000" MS_POSITIONING="GridLayout">
<FORM id="Form1" method="post" runat="server">
<asp:button id="ButtonLogout" style="Z-INDEX: 119; LEFT: 664px;
POSITION: absolute; TOP: 64px" onclick="MLogout" runat="server" Text="Logout" Font-
Underline="True" Font-Size="Smaller" ForeColor="Red" Font-Names="Times New Roman" Font-
Bold="True" BorderColor="Red" BorderStyle="Outset" BackColor="White" Height="24px"
Width="56px"></asp:button>
<asp:Image id="Image1" style="Z-INDEX: 124; LEFT: 8px; POSITION:
absolute; TOP: 8px" runat="server" Height="80px" Width="96px"
ImageUrl="title_Links.gif"></asp:Image><asp:button id="ButtonMAdd" style="Z-INDEX: 121; LEFT:
648px; POSITION: absolute; TOP: 424px" onclick="MAdd" tabIndex="90" runat="server" Text="Add"
Font-Size="Larger" ForeColor="Red" Font-Names="Times New Roman" Font-Bold="True"
BorderColor="Red" BorderStyle="Outset" BackColor="White" Height="30px"
Width="100px"></asp:button><asp:button id="ButtonMClear" style="Z-INDEX: 118; LEFT: 648px;
POSITION: absolute; TOP: 544px" onclick="MClear" tabIndex="120" runat="server" Text="Clear" Font-
Size="Larger" ForeColor="Red" Font-Names="Times New Roman" Font-Bold="True"
BorderColor="Red" BorderStyle="Outset" BackColor="White" Height="30px"
Width="100px"></asp:button><asp:button id="ButtonMDelete" style="Z-INDEX: 117; LEFT: 648px;
POSITION: absolute; TOP: 504px" onclick="MDelete" tabIndex="110" runat="server" Text="Delete"
Font-Size="Larger" ForeColor="Red" Font-Names="Times New Roman" Font-Bold="True"
BorderColor="Red" BorderStyle="Outset" BackColor="White" Height="30px"
Width="100px"></asp:button><asp:button id="ButtonMModify" style="Z-INDEX: 116; LEFT: 648px;
POSITION: absolute; TOP: 464px" onclick="MModify" tabIndex="100" runat="server" Text="Modify"
Font-Size="Larger" ForeColor="Red" Font-Names="Times New Roman" Font-Bold="True"
BorderColor="Red" BorderStyle="Outset" BackColor="White" Height="30px"
Width="100px"></asp:button><asp:label id="LabelMCity" style="Z-INDEX: 115; LEFT: 320px;
POSITION: absolute; TOP: 448px" runat="server" ForeColor="Red" Font-Names="Times New Roman"
Font-Bold="True" BorderColor="Red" BorderStyle="Outset" BackColor="White" Height="30px"
```



```

Width="97px">Cause</asp:label><asp:label id="LabelMStreet" style="Z-INDEX: 114; LEFT: 16px;
POSITION: absolute; TOP: 513px" runat="server" ForeColor="Red" Font-Names="Times New Roman"
Font-Bold="True" BorderColor="Red" BorderStyle="Outset" BackColor="White" Height="30px"
Width="105px">Failure Mode</asp:label><asp:label id="LabelMFName" style="Z-INDEX: 113; LEFT:
16px; POSITION: absolute; TOP: 480px" runat="server" ForeColor="Red" Font-Names="Times New
Roman" Font-Bold="True" BorderColor="Red" BorderStyle="Outset" BackColor="White" Height="30"
Width="105"> Unit</asp:label><asp:label id="LabelMLName" style="Z-INDEX: 112; LEFT: 16px;
POSITION: absolute; TOP: 448px" runat="server" ForeColor="Red" Font-Names="Times New Roman"
Font-Bold="True" BorderColor="Red" BorderStyle="Outset" BackColor="White" Height="30px"
Width="105px"> System</asp:label><asp:label id="LabelMState" style="Z-INDEX: 111; LEFT: 320px;
POSITION: absolute; TOP: 480px" runat="server" ForeColor="Red" Font-Names="Times New Roman"
Font-Bold="True" BorderColor="Red" BorderStyle="Outset" BackColor="White" Height="30"
Width="97">Effects</asp:label><asp:label id="LabelMZip" style="Z-INDEX: 110; LEFT: 320px;
POSITION: absolute; TOP: 513px" runat="server" ForeColor="Red" Font-Names="Times New Roman"
Font-Bold="True" BorderColor="Red" BorderStyle="Outset" BackColor="White" Height="30px"
Width="97px">Solution</asp:label><asp:textbox id="TextBoxMState" style="Z-INDEX: 109; LEFT:
424px; POSITION: absolute; TOP: 479px" tabIndex="50" runat="server" ForeColor="Black"
BorderColor="Red" BorderStyle="Outset" BackColor="White" Height="30px"
Width="180px"></asp:textbox><asp:textbox id="TextBoxMLName" style="Z-INDEX: 108; LEFT:
128px; POSITION: absolute; TOP: 448px" tabIndex="10" runat="server" ForeColor="Black"
BorderColor="Red" BorderStyle="Outset" BackColor="White" Height="30px"
Width="180px"></asp:textbox><asp:textbox id="TextBoxMCity" style="Z-INDEX: 107; LEFT: 424px;
POSITION: absolute; TOP: 447px" tabIndex="40" runat="server" ForeColor="Black" BorderColor="Red"
BorderStyle="Outset" BackColor="White" Height="30px" Width="180px"></asp:textbox><asp:textbox
id="TextBoxMStreet" style="Z-INDEX: 106; LEFT: 128px; POSITION: absolute; TOP: 512px"
tabIndex="30" runat="server" ForeColor="Black" BorderColor="Red" BorderStyle="Outset"
BackColor="White" Height="30px" Width="180px"></asp:textbox><asp:textbox id="TextBoxMFName"
style="Z-INDEX: 105; LEFT: 128px; POSITION: absolute; TOP: 480px" tabIndex="20" runat="server"
ForeColor="Black" BorderColor="Red" BorderStyle="Outset" BackColor="White" Height="30"
Width="180px"></asp:textbox><asp:label id="LabelMember" style="Z-INDEX: 101; LEFT: 112px;
POSITION: absolute; TOP: 24px" runat="server" Font-Underline="True" Font-Size="Large"
ForeColor="Red" Font-Names="Times New Roman" Font-Bold="True" BorderColor="Red"
BorderStyle="Outset" BackColor="White" Height="24px" Width="560px">UC Robotics Team Robot
Failure Modes Information</asp:label><asp:dropdownlist id="DDMemberID" style="Z-INDEX: 102;
LEFT: 120px; POSITION: absolute; TOP: 416px" runat="server" ForeColor="Red" Font-Names="Times
New Roman" Font-Bold="True" BackColor="White" Height="30px" Width="180px"
AutoPostBack="True" OnSelectedIndexChanged="DDMember_IDSelect"></asp:dropdownlist><asp:label
id="LabelMID" style="Z-INDEX: 103; LEFT: 16px; POSITION: absolute; TOP: 411px" runat="server"
ForeColor="Red" Font-Names="Times New Roman" Font-Bold="True" BorderColor="Red"
BorderStyle="Outset" BackColor="White" Height="30px"
Width="97px">FailureID</asp:label><asp:textbox id="TextBoxMZip" style="Z-INDEX: 104; LEFT:
424px; POSITION: absolute; TOP: 512px" tabIndex="60" runat="server" ForeColor="Black"
BorderColor="Red" BorderStyle="Outset" BackColor="White" Height="30px"
Width="180px"></asp:textbox>
<div dataFormatAs="html" style="Z-INDEX: 120; BORDER-LEFT-COLOR:
#ff0033; LEFT: 8px; BORDER-BOTTOM-COLOR: #ff0033; OVERFLOW: auto; WIDTH: 806px;
COLOR: red; BORDER-TOP-STYLE: outset; BORDER-TOP-COLOR: #ff0033; BORDER-RIGHT-
STYLE: outset; BORDER-LEFT-STYLE: outset; POSITION: absolute; TOP: 96px; HEIGHT: 298px;
BACKGROUND-COLOR: transparent; TEXT-DECORATION: underline; BORDER-RIGHT-COLOR:
#ff0033; BORDER-BOTTOM-STYLE: outset"><asp:datagrid id="DGMember" runat="server" Font-
Names="Times New Roman" BorderColor="Red" BorderStyle="Outset" BackColor="White"
Height="292px" Width="496px" PageSize="5" BorderWidth="0mm" HorizontalAlign="Center">
<SelectedItemStyle Wrap="False"></SelectedItemStyle>
<EditItemStyle Wrap="False"></EditItemStyle>
<AlternatingItemStyle Wrap="False"
HorizontalAlign="Center" VerticalAlign="Middle"></AlternatingItemStyle>
<ItemStyle Font-Names="Times New Roman" Wrap="False"
HorizontalAlign="Center" ForeColor="Red" BorderStyle="Outset" VerticalAlign="Middle"></ItemStyle>

```

```

                <HeaderStyle Font-Size="Larger" Font-Underline="True"
Font-Bold="True" Wrap="False" HorizontalAlign="Center" ForeColor="Red" BorderStyle="Outset"
VerticalAlign="Middle" BackColor="Black"></HeaderStyle>
                <PagerStyle VerticalAlign="Middle" BorderColor="Red"
HorizontalAlign="Center" Wrap="False"></PagerStyle>
            </asp:datagrid></div>
            <asp:textbox id="TextBoxTemp" style="Z-INDEX: 122; LEFT: 320px;
POSITION: absolute; TOP: 416px" runat="server" Height="24px" Width="94px"
Visible="False"></asp:textbox><asp:textbox id="TextBoxTemp2" style="Z-INDEX: 123; LEFT: 432px;
POSITION: absolute; TOP: 416px" runat="server" Height="24px" Width="104px"
Visible="False"></asp:textbox></FORM>
        </body>
</HTML>

```

Files Form

```

<%@ Import Namespace="System.IO"%>
<HTML>

```

```

    <HEAD>
        <title>File Management</title>
        <script language="VB" runat="server">

```

```

Dim currentDir As String
Dim directorySeparatorChar As Char = Path.DirectorySeparatorChar

```

```

Sub Page_Load(sender As Object, e As EventArgs)
If Session("Log")="A" OR Session("Log")= "U" then

```

```

    Dim root As String = "f:\wwwroot\sujan\thesis1\Docs"
    Dim thisPage As String = Request.Path

```

```

    currentDir = Request.Params("dir")
    If currentDir Is Nothing Then
        currentDir = root
    End If
    If Not currentDir.StartsWith(root) Then
        currentDir = root
    End If

```

```

Dim sb As New StringBuilder(4096)

```

```

If Not currentDir.Equals(Root) Then
    ' not at the root
    Dim currentDirParent As String
    Dim lastIndex As Integer = _
        currentDir.LastIndexOf(directorySeparatorChar)
    If lastIndex <> -1 Then
        currentDirParent = currentDir.Substring(0, lastIndex)
    Else
        currentDirParent = currentDir
    End If
    sb.Append("<a href=").Append(thisPage)
    sb.Append("&dir=").Append(Server.UrlEncode(currentDirParent))
    sb.Append("><img width=30 border=0 src=Up.gif></a><br>")
End If

```

```

DoUpload()

```

```

sb.Append("<br><img border=0 src=OpenFolder.gif> ")
sb.Append("<font face=verdana>")
'sb.Append(currentDir)
sb.Append("</font>")
sb.Append("<br>")

sb.Append("<table>")
sb.Append("<tr bgcolor=#D8D8D8>")
sb.Append("<td width=200><font face=verdana size=3>Name</font></td>")
sb.Append("<td><font face=verdana size=3>Type</font></td>")
sb.Append("<td><font face=verdana size=3>Size</font></td>")
sb.Append("<td><font face=verdana size=3>Modified</font></td>")
sb.Append("</tr>")

```

Dim dirs() As String

Try

```
dirs = Directory.GetDirectories(currentDir)
```

Dim d As String

For Each d In dirs

```
Dim dirName As String = Path.GetFileName(d)
```

```
sb.Append("<tr>")
```

```
sb.Append("<td><img src=Folder.gif> ")
```

```
sb.Append("<a href=").Append(thisPage)
```

```
sb.Append("?dir=").Append(Server.UrlEncode(currentDir))
```

```
sb.Append(directorySeparatorChar)
```

```
sb.Append(Server.UrlEncode(dirName))
```

```
sb.Append("color=#ff0000>").Append(dirName).Append("</a>")
```

```
sb.Append("</td>")
```

```
sb.Append("<td><font face=verdana size=2 color=#ff0000>folder</font></td>")
```

```
sb.Append("<td> </td>")
```

```
sb.Append("<td><font face=verdana size=2 color=#ff0000>")
```

```
sb.Append(Directory.GetLastWriteTime(currentDir & _
directorySeparatorChar.ToString() & dirName).ToString())
```

```
sb.Append("</font></td>")
```

```
sb.Append("</tr>")
```

Next

Catch ex As Exception

End Try

Try

```
Dim dirInfo As New DirectoryInfo(currentDir)
```

```
Dim files() As FileInfo
```

```
files = dirInfo.GetFiles()
```

Dim f As FileInfo

For Each f In files

```
Dim filename As String = f.Name
```

```
sb.Append("<tr>")
```

```
sb.Append("<td><img src=File.gif> ")
```

```
sb.Append("<a href=FileDownload.aspx?file=")
```

```
sb.Append(Server.UrlEncode(currentDir))
```

```
sb.Append(directorySeparatorChar)
```

```

sb.Append(Server.UrlEncode(filename))
sb.Append(">").Append(filename).Append("</a>")
sb.Append("</td>")
sb.Append("<td><font face=verdana size=2 color=#ff0000 >file</font></td>")
sb.Append("<td><font face=verdana size=2 color=#ff0000 >")
sb.Append(f.Length.ToString())
sb.Append("</font></td>")
sb.Append("<td><font face=verdana size=2 color=#ff0000>")
sb.Append(File.GetLastWriteTime(currentDir & _
    directorySeparatorChar.ToString() & f.Name).ToString())
sb.Append("</font></td>")
sb.Append("</tr>")
Next
Catch ex As Exception
End Try

sb.Append("</table>")
dirContent.Text = sb.ToString()
If Session("Log")<>"A" then
Fileup.Visible=False
Upload.Visible=False
uploadedfile.visible=False
End IF
else
response.redirect("http://10.85.2.251/sujan/thesis1/FrmLogin.aspx")
End IF
End Sub

Sub DoUpload()

If Not (uploadedFile.PostedFile Is Nothing) Then
Try
Dim postedFile = uploadedFile.PostedFile
Dim filename As String = Path.GetFileName(postedFile.FileName)
Dim contentType As String = postedFile.ContentType
Dim contentLength As Integer = postedFile.ContentLength
postedFile.SaveAs(currentDir & _
    directorySeparatorChar.ToString() & filename)
Catch ex As Exception
message.Text = "Failed uploading file"
End Try
End If
End Sub

Sub MLogout(S As Object, E As EventArgs)
Session.abandon()
response.redirect("http://10.85.2.251/sujan/thesis1/FrmLogin.aspx")
End Sub

</script>
</HEAD>
<body bgColor="#000000">
<form runat="server" enctype="multipart/form-data" ID="Form1">
<asp:Image id="Imagefile" Runat="server"
ImageUrl="title_Links.gif"></asp:Image>

```

```

        <asp:Label id="Title" Runat="server" Width="424px" BackColor="White"
BorderColor="Red" BorderStyle="Outset" Font-Bold="True" Font-Names="Times New Roman" Font-
Size="Large" Font-Underline="True" ForeColor="Red">
        Uc Robotics Team Important Files</asp:Label>
        <asp:LinkButton ID="Logout" Runat="server" OnClick="MLogout"
BackColor="White" BorderColor="Red" BorderStyle="Outset" Font-Bold="True" Font-Names="Times
New Roman" ForeColor="Red" Width="64px" Height="32px">
        Logout</asp:LinkButton>
        <P>
                <asp:Label id="dirContent" runat="server" ForeColor="Red" />
                <asp:Label id="message" runat="server" ForeColor="Red" />
        </P>
        <p>
                <hr>
                <%-- File Upload --%>
                <font face="verdana" color="red"><STRONG>
                        <asp:Label ID="fileup" Runat="server">Select file to
upload</asp:Label></STRONG></font>
                        <input id="uploadedFile" type="file" runat="server"
NAME="uploadedFile"> <input type="button" id="upload" value="Upload" OnServerClick="Page_Load"
runat="server" NAME="upload">
                <p>
                        </form>
                        &nbsp;</P>
        </body>
</HTML>

```